

CONNECTOR ILLUSTRATION



BOSCH NUMBER

CONNECTOR TYPE

J-48817-183

E02FL-RS

TRAY

13

SERVICE MANUAL SYMBOL

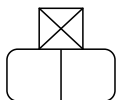

TERMINAL ILLUSTRATION

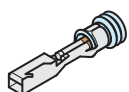

BOSCH NUMBER

TERMINAL TYPE

J-48817-206

RSF-S-RN

TRAY

5

STG

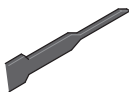
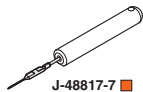
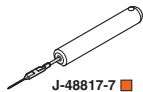

SOLDER SLEEVE CONNECTORS

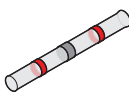

**RETAINER REMOVAL METHOD**

1. Place the RRT (04A) in the slot at the edge of the retainer.

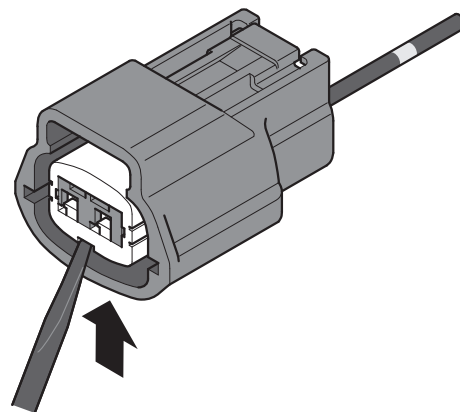

2. Use the RRT as a lever to gently lift the retainer. Remove the retainer from the connector.

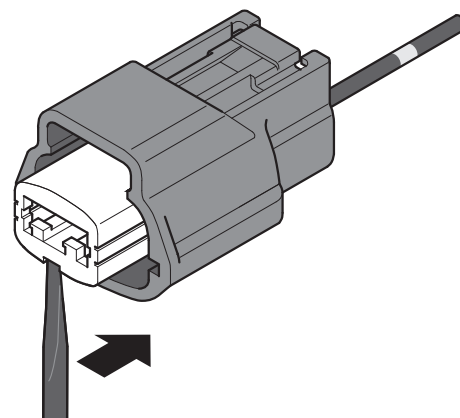

**TERMINAL REMOVAL METHOD**

1. Insert the TRT (11A) straight into the slot on the face of the connector near the terminal with the long side of the TRT touching the terminal.

**NOTE: Locking tab is part of connector.**

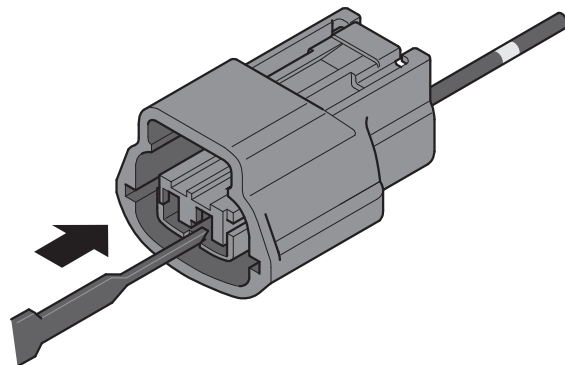

2. Move the TRT upward slightly to release the locking tab and then pull the wire out slowly.

