

**MITSUBISHI
MOTORS**

Drive your Ambition

Essential Tool Audit

MARCH 2021

Dealer Name: _____

Dealer Code: _____

Dealer Address: _____

City: _____

State and Zip Code: _____

Dealer Contact Name: _____

Title: _____

Dealer Signature: _____

Date Completed: _____







































DRAWER 1

MITSUBISHI

ESSENTIAL TOOL AUDIT — 2021

Dealer Code: _____

- Inspect tool drawer.
- Place a check mark on each tool located. Circle missing tools.

| A | B | C | D | E | F |
|---|---|---|--|--|---|
|  MIT49700 VALVE SPRING COMPRESSOR | |  MD998375-01 CRANKSHAFT FRONT OIL SEAL INST. |  MIT46716 TPMS MAGNET |  MD998245-01 LOCK PIN INSTALLER |  MB990779-01 BAR, INSTALLATION OF DIFFERENTIAL SIDE BEARING OUTER RACE |
| |  MD998373-01 SILENT SHAFT BEARING INSTALLER |  MD998376-01 CRANKSHAFT REAR OIL SEAL INST. |  MB991705-01 ADAPTER TEST FITTING | |  MB992854-01 MAGNETIC BASE PLATE |
|  MB992226 SERRATION SOCKET | |  MD998776-01 CRANKSHAFT REAR SEAL INSTALLER |  MD998713-01 CAMSHAFT OIL SEAL INSTALLER |  MD998412 OIL PUMP GUIDE (PAIR) | |
|  MB991636-01 REDUCTION BRAKE ADJUSTER - STOPPER | | |  MB991559-01 OIL SEAL INSTALLER | | |
|  MD998364-01 CAMSHAFT OIL SEAL INSTALLER | | |  MB992103-01 TIMING CHAIN WEDGE | | |
|  MIT47026 VALVE SPRING COMPRESSOR ADAPTER | |  MD998718-01 CRANKSHAFT REAR OIL SEAL INST. | |  MD998738-01 SET SCREW | |
|  MB992276 REMOVER, DRIVE BELT |  MIT304204 DRAW BAR | | |  MB990947-01 DRIVER GUIDE | |
|  MB992275 INSTALLER, DRIVE BELT | | | | | |
|  MB992042-01 ENGINE COOLANT TEMPERATURE SENSOR WRENCH | |  MB992183-01 INSTALLER, CK/SHAFT RR OIL SEAL |  MD998717-01 FRONT OIL SEAL INSTALLER | |  MD998374-01 BEARING INSTALLER STOP |
|  MD998371-01 BEARING PULLER ADAPTER | | |  MD998285-01 OIL SEAL GUIDE | | |
|  MD998372-01 INSTALLER, BEARING | | |  MD998716-01 CRANKSHAFT WRENCH | | |
|  MIT220432 AUTO TRANS OIL PRESSURE GAUGE ADAPTER | |  MB991999-01 VALVE STEM SEAL INSTALLER | | | |
|  MD998752-01 PULLEY WRENCH | |  MD998737-01 VALVE STEM SEAL INSTALLER | | | |
|  MD998779-01 SILENT SHAFT HOLDING TOOL | |  MD998774-01 VALVE STEM SEAL INSTALLER | | | |

ESSENTIAL TOOLS

| | | | | | |
|--------------------|-------------------|-------------------|-------------------|-------------------|-------------------|
| ↑ | ↑ | ↑ | ↑ | ↑ | ↑ |
| Qty. 10 D-20-05 | Qty. 2 D-20-05 | Qty. 5 D-20-07 | Qty. 7 D-20-04 | Qty. 2 D-20-05 | Qty. 1 D-20-06 |

DIVIDERS

DRAWER 1

MITSUBISHI

ESSENTIAL TOOL AUDIT — 2021

Dealer Code: _____

- Inspect tool drawer.
- Place a check mark on each tool located. Circle missing tools.
- Enter total price of missing tools, then initial "Drawer Completed."

| LOCATION | TOOL# | TOOL DESCRIPTION | UNIT PRICE | ORDER QTY |
|----------|-------------|--|------------|-----------|
| A1 | MD998779-01 | SILENT SHAFT HOLDING TOOL | 69.88 | |
| A2 | MD998752-01 | PULLEY WRENCH | 22.84 | |
| A2 | MIT220432 | AUTO TURNS OIL PRESSURE GAUGE ADAPTER | 44.54 | |
| A3 | MD998371-01 | BEARING PULLER ADAPTER | 35.67 | |
| A3 | MD998372-01 | INSTALLER, BEARING | 35.73 | |
| A4 | MB992042-01 | ENGINE COOLANT TEMPERATURE SENSOR WRENCH | 120.70 | |
| A5 | MB992275 | INSTALLER, DRIVE BELT | 21.37 | |
| A6 | MB992276 | REMOVER, DRIVE BELT | 37.47 | |
| A7 | MIT47026 | VALVE SPRING COMPRESSOR ADAPTER | 39.56 | |
| A8 | MD998364-01 | CAMSHAFT OIL SEAL INSTALLER | 17.32 | |
| A9 | MB991636-01 | REDUCTION BRAKE ADJUSTER - STOPPER | 23.46 | |
| A10 | MB992226 | SERRATION SOCKET | 58.01 | |
| A11 | MIT49700 | VALVE SPRING COMPRESSOR | 146.08 | |
| B1 | MIT304204 | DRAW BAR | 229.94 | |
| B2 | MD998373-01 | SILENT SHAFT BEARING INSTALLER | 102.47 | |
| C1 | MB991999-01 | VALVE STEM SEAL INSTALLER | 28.45 | |
| C1 | MD998737-01 | VALVE STEM SEAL INSTALLER | 33.20 | |
| C1 | MD998774-01 | VALVE STEM SEAL INSTALLER | 23.37 | |
| C2 | MB992183-01 | INSTALLER,CK/SHAFT RR OIL SEAL | 54.14 | |
| C3 | MD998718-01 | CRANKSHAFT REAR OIL SEAL INSTALLER | 47.21 | |
| C4 | MD998776-01 | CRANKSHAFT REAR SEAL INSTALLER | 52.03 | |
| C5 | MD998376-01 | CRANKSHAFT REAR OIL SEAL INSTALLER | 28.59 | |
| C6 | MD998375-01 | CRANKSHAFT FRONT OIL SEAL INSTALLER | 49.64 | |
| D1 | MD998716-01 | CRANKSHAFT WRENCH | 23.93 | |
| D2 | MD998285-01 | OIL SEAL GUIDE | 43.47 | |
| D3 | MD998717-01 | FRONT OIL SEAL INSTALLER | 59.20 | |
| D4 | MB992103-01 | TIMING CHAIN WEDGE | 37.13 | |
| D5 | MB991559-01 | OIL SEAL INSTALLER | 40.11 | |
| D6 | MD998713-01 | CAMSHAFT OIL SEAL INSTALLER | 32.07 | |
| D7 | MB991705-01 | ADAPTER TEST FITTING | 37.08 | |
| D8 | MIT46716 | TPMS MAGNET | 27.56 | |
| E1 | MB990947-01 | DRIVER GUIDE | 49.11 | |
| E1 | MD998738-01 | SET SCREW | 37.23 | |
| E2 | MD998412 | OIL PUMP GUIDE (PAIR) | 19.46 | |
| E3 | MD998245-01 | LOCK PIN INSTALLER | 14.82 | |
| F1 | MD998374-01 | BEARING INSTALLER STOP | 59.17 | |
| F2 | MB990779-01 | BAR, INSTALLER | 49.06 | |
| F2 | MB992854-01 | MAGNETIC BASE PLATE | 116.39 | |
| | FR01 | BLACK FOAM DRAWER LINER | 11.95 | |
| | D-20-04 | DIVIDER | 0.61 | |
| | D-20-05 | DIVIDER | 0.61 | |
| | D-20-06 | DIVIDER | 0.61 | |
| | D-20-07 | DIVIDER | 0.64 | |

Note: Components of a kit are included when ordering the kit number. *Component of a kit. All pricing is subject to change.

Drawer Completed: _____
Initial

Drawer Total Essential Tools: _____



























DRAWER 2

MITSUBISHI

ESSENTIAL TOOL AUDIT — 2021

Dealer Code: _____

- Inspect tool drawer.
- Place a check mark on each tool located. Circle missing tools.

| A | B | C | D |
|--|--|---|---|
| MD998742-01 GAUGE ADAPTER  | MD998903 CLUTCH SPRING COMPRESSOR  | MD998807-01 ROLL PIN REMOVER  | MB992853-01 ENGINE HANGER  |
| 14513 CAP SCREW USED WITH MD998742-01  | MB992310-01 TCSST TRANSAXLE CASE (LH) OIL SEAL  | | MB991956-01 ENGINE HANGER  |
| MB990607-01 TORQUE WRENCH SOCKET  | MB992312-01 INSTALLER, OIL SEAL  | | MB992208-01 ENGINE HANGER PLATE  |
| MIT215144 GAUGE ADAPTER  | MB991480-01 FUEL TANK LOCK RING WRENCH  | MB992311-01 GUIDE, OIL SEAL  | MB992012-01 ENGINE HANGER PLATE (A)  |
| MB991146-01 CAMSHAFT DOWEL PIN INSTALLER  | MB992202-01 WRENCH, FUEL TANK  | MB992313-01 INSTALLER, OIL SEAL  | MB992013-01 ENGINE HANGER PLATE (B)  |
| MB992324-01 GUIDE A, SEAL COVER  | MB992909-01 WRENCH, FUEL TANK (ADAPTER)  | | MB992323-01 INSTALLER, SEAL COVER  |
| MB992325-01 GUIDE B, SEAL COVER  | MB992332-01 CLUTCH REMOVAL TOOL, TCSST  | MB992314-01 GUIDE, V RING (TCSST)  | |
| MD998162-01 SPANNER  | | | |
| MD998773-01 KNOCK SENSOR SOCKET  | | | |

Qty. 7
D-20-04

Qty. 4
D-20-08

Qty. 3
D-20-05

Qty. 2
D-20-15

DIVIDERS

DRAWER 2

MITSUBISHI

ESSENTIAL TOOL AUDIT — 2021

Dealer Code: _____

- Inspect tool drawer.
- Place a check mark on each tool located. Circle missing tools.
- Enter total price of missing tools, then initial "Drawer Completed."

| LOCATION | TOOL# | TOOL DESCRIPTION | UNIT PRICE | ORDER QTY |
|----------|-------------|------------------------------------|------------|-----------|
| A1 | MD998773-01 | KNOCK SENSOR SOCKET | 136.13 | |
| A2 | MD998162-01 | SPANNER | 29.28 | |
| A3 | MB992324-01 | GUIDE A, SEAL COVER | 14.59 | |
| A3 | MB992325-01 | GUIDE B, SEAL COVER | 16.59 | |
| A4 | MB991146-01 | CAMSHAFT DOWEL PIN INSTALLER | 8.64 | |
| A5 | MIT215144 | GAUGE ADAPTER | 36.95 | |
| A6 | MB990607-01 | TORQUE WRENCH SOCKET | 11.35 | |
| A7 | 14513-PK5 | CAP SCREW USED WITH MD998742-01 | 4.95 | |
| A8 | MD998742-01 | GAUGE ADAPTER | 39.30 | |
| B1 | MB992332-01 | CLUTCH REMOVAL TOOL, TCSST | 79.88 | |
| B2 | MB991480-01 | FUEL TANK LOCK RING WRENCH | 40.79 | |
| B2 | MB992202-01 | WRENCH, FUEL TANK | 26.96 | |
| B2 | MB992909-01 | WRENCH, FUEL TANK (ADAPTER) | 27.52 | |
| B3 | MB992312-01 | INSTALLER, OIL SEAL | 45.17 | |
| B4 | MB992310-01 | TCSST TRANSAXLE CASE (LH) OIL SEAL | 98.98 | |
| B5 | MD998903 | CLUTCH SPRING COMPRESSOR | 101.40 | |
| C1 | MB992314-01 | GUIDE, V RING (TCSST) | 121.49 | |
| C2 | MB992313-01 | INSTALLER, OIL SEAL | 61.47 | |
| C3 | MB992311-01 | GUIDE, OIL SEAL | 72.16 | |
| C4 | MD998807-01 | ROLL PIN REMOVER | 64.34 | |
| D1 | MB992323-01 | INSTALLER, SEAL COVER | 108.98 | |
| D2 | MB991956-01 | ENGINE HANGER | 16.14 | |
| D2 | MB992012-01 | ENGINE HANGER PLATE (A) | 57.00 | |
| D2 | MB992013-01 | ENGINE HANGER PLATE (B) | 74.00 | |
| D2 | MB992208-01 | ENGINE HANGER PLATE | 53.22 | |
| D3 | MB992853-01 | ENGINE HANGER | 64.59 | |
| | FR01 | BLACK FOAM DRAWER LINER | 11.95 | |
| | D-20-04 | DIVIDER | 0.61 | |
| | D-20-05 | DIVIDER | 0.61 | |
| | D-20-08 | DIVIDER | 0.61 | |
| | D-20-15 | DIVIDER | 0.82 | |

Note: Components of a kit are included when ordering the kit number. *Component of a kit. All pricing is subject to change.

Drawer Completed: _____
Initial

Drawer Total Essential Tools: _____







































DRAWER 3

MITSUBISHI

ESSENTIAL TOOL AUDIT — 2021

Dealer Code: _____

- Inspect tool drawer.
- Place a check mark on each tool located. Circle missing tools.

| A | B | C | D | E | F |
|--|--|---|--|--|--|
| MB990938-01 HANDLE  MB992038-01 PRELOAD SOCKET  | MB992221-01 PULLER SET KIT  MB992210-01 OIL SEAL INSTALLER  | MIT44802 COLLET SET (2-PIECES)  MIT45287 COLLET SET (2-PIECES)  MB992127-01 ADAPTER  | MB992206-01 OIL SEAL INSTALLER  MB992140-01 OIL SEAL INSTALLER  MB992138-01 INSTALLER HANDLE  | MB992220-01 INPUT SHAFT ADAPTER  MB992219-01 OUTPUT SHAFT ADAPTER  MD998802-01 INPUT SHAFT HOLDER  MIT4336 BEARING DRIVER HANDLE  | MB992873-01 SEAL INSTALLER  MIT27537 DRIVE PLATE  MIT27526 DRIVE PLATE  |
| MB990662-1-01 FITTING  MB990662-2-01 FITTING  | MD998829-01 BEARING INSTALLER  | MD998818-01 BEARING INSTALLER ADAPTER, 44MM  MD998818-01 BEARING INSTALLER ADAPTER, 38MM  | MIT304180-A INSTALLER HANDLE  | | MB990799-01 AXLE BEARING REMOVER/INSTALLER  |
| MB990228-01 PRELOAD SOCKET  | MD998822-01 BEARING INSTALLER  | MD998817-01 BEARING INSTALLER ADAPTER, 34MM  | | | |
| MB990941-01 TORQUE TUBE BEARING INSTALLER  | MD998834-01 OIL PUMP OIL SEAL INSTALLER  | MD998816-01 BEARING INSTALLER ADAPTER, 30MM  | | | MB992039-01 SLIDE HAMMER PULLER  |
| MB990031-01 DRIVE PINION OIL SEAL INSTALLER  | MD998823-01 BEARING INSTALLER  | MD998824-01 BEARING INSTALLER ADAPTER, 50MM  | | | |
| MB991168-01 DIFFERENTIAL SEAL INSTALLER  | | MD998820-01 INSTALLER ADAPTER, 42MM  | MB992037-01 INPUT SHAFT OIL SEAL INSTALLER  | | MB992216-01 TRANSMISSION INSTALLER (5TH GEAR)  |
| MB992141-01 OIL SEAL INSTALLER  | | | | | |

ESSENTIAL TOOLS

| | | | | | |
|-------------------|-------------------|-------------------|-------------------|-------------------|-------------------|
| ↑ | ↑ | ↑ | ↑ | ↑ | ↑ |
| Qty. 6 D-30-05 | Qty. 5 D-20-05 | Qty. 9 D-20-05 | Qty. 4 D-20-05 | Qty. 3 D-20-05 | Qty. 5 D-20-07 |

DIVIDERS

DRAWER 3

MITSUBISHI

ESSENTIAL TOOL AUDIT — 2021

Dealer Code: _____

- Inspect tool drawer.
- Place a check mark on each tool located. Circle missing tools.
- Enter total price of missing tools, then initial "Drawer Completed."

| LOCATION | TOOL# | TOOL DESCRIPTION | UNIT PRICE | ORDER QTY |
|----------|----------------|-----------------------------------|------------|-----------|
| A1 | MB992141-01 | OIL SEAL INSTALLER | 57.91 | |
| A2 | MB991168-01 | DIFFERENTIAL SEAL INSTALLER | 21.89 | |
| A3 | MB990031-01 | DRIVE PINION OIL SEAL INSTALLER | 62.61 | |
| A4 | MB990941-01 | TORQUE TUBE BEARING INSTALLER | 52.81 | |
| A5 | MB990228-01 | PRELOAD SOCKET | 43.18 | |
| A6 | *MB990662-1-01 | FITTING, COMPONENT OF MB990662-01 | 48.41 | |
| A6 | *MB990662-2-01 | FITTING, COMPONENT OF MB990662-01 | 63.50 | |
| A7 | MB990938-01 | HANDLE | 22.13 | |
| A7 | MB992038-01 | PRELOAD SOCKET | 27.79 | |
| B1 | MD998323-01 | BEARING INSTALLER | 36.43 | |
| B2 | MD998334-01 | OIL PUMP OIL SEAL INSTALLER | 51.57 | |
| B3 | MD998822-01 | BEARING INSTALLER ADAPTER, 46MM | 27.67 | |
| B4 | MD998829-01 | BEARING INSTALLER | 25.86 | |
| B5 | MB992210-01 | OIL SEAL INSTALLER | 54.25 | |
| B6 | MB992221-01 | PULLER SET KIT | 25.95 | |
| C1 | MD998820-01 | INSTALLER ADAPTER, 42MM | 35.10 | |
| C2 | MD998824-01 | BEARING INSTALLER ADAPTER, 50MM | 31.13 | |
| C3 | MD998816-01 | BEARING INSTALLER ADAPTER, 30MM | 13.89 | |
| C4 | MD998817-01 | BEARING INSTALLER ADAPTER, 34MM | 12.41 | |
| C5 | MD998818-01 | BEARING INSTALLER ADAPTER, 38MM | 14.04 | |
| C6 | MD998821-01 | BEARING INSTALLER ADAPTER, 44MM | 14.39 | |
| C8 | MB992127-01 | ADAPTER | 20.23 | |
| C9 | MIT45287 | COLLET SET | 144.01 | |
| C10 | MIT44802 | COLLET SET | 42.40 | |
| D1 | MB992037-01 | INPUT SHAFT OIL SEAL INSTALLER | 29.97 | |
| D2 | MIT304180-A | INSTALLER HANDLE | 121.25 | |
| D3 | MB992138-01 | BEARING INSTALLER | 29.14 | |
| D4 | MB992140-01 | OIL SEAL INSTALLER | 42.35 | |
| D5 | MB992206-01 | OIL SEAL INSTALLER | 58.20 | |
| E1 | MIT4336 | BEARING DRIVER HANDLE | 80.63 | |
| E2 | MD998802-01 | INPUT SHAFT HOLDER | 134.25 | |
| E3 | MB992219-01 | OUTPUT SHAFT ADAPTER | 162.59 | |
| E4 | MB992220-01 | INPUT SHAFT ADAPTER | 33.39 | |
| F1 | MB992216-01 | TRANSMISSION INSTALLER (5TH GEAR) | 120.96 | |
| F2 | MB992039-01 | SLIDE HAMMER PULLER | 424.80 | |
| F3 | MB990799-01 | AXLE BEARING REMOVER/INSTALLER | 35.48 | |
| F4 | MIT27526 | DRIVE PLATE | 20.65 | |
| F5 | MIT27526 | DRIVE PLATE | 18.33 | |
| F6 | MIT27537 | SEAL INSTALLER | 22.10 | |
| | FR01 | BLACK FOAM DRAWER LINER | 11.95 | |
| | D-30-05 | DIVIDER | 0.73 | |
| | D-30-07 | DIVIDER | 0.82 | |

Note: Components of a kit are included when ordering the kit number. *Component of a kit. All pricing is subject to change.

Drawer Completed: _____
Initial

Drawer Total Essential Tools: _____





























DRAWER 4

MITSUBISHI

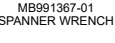
ESSENTIAL TOOL AUDIT — 2021

Dealer Code: _____

- Inspect tool drawer.
- Place a check mark on each tool located. Circle missing tools.

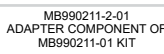
| A | B | C | D | E | F |
|---|--|---|--|---|---|
| <p>J-44372 5-60 LB PULL GAUGE</p>  | <p>MB991448-01 BUSH REMOVER & INSTALLER BASE</p>  | <p>MB992164 DOOR GLASS ADJUST BLOCK SET (BLUE / PS28)</p>  | <p>MB990211-01 SLIDE HAMMER WITH ADAPTER KIT</p>  | <p>MB990998-01 FRONT HUB REMOVER/INSTALLER</p>  | <p>MB990767-01 END YOKE HOLDER</p>  |
| | <p>MB990800 BALL JOINT DUST COVER INSTALLER</p>  | <p>MB992050 DELTA GLASS ADJUST BLOCK SET</p>  | | <p>MB992867-01 KNUCKLE ARM BRIDGE SPACER</p>  | <p>MIT308239 CRANK/CAMSHAFT PULLEY HOLDER PIN</p>  |
| | <p>MB990889 REAR SUSPENSION BUSHING RING</p>  | <p>MB992053 DOOR GLASS ADJUST BLOCK SET (BLUE / PS24)</p>  | | <p>MB991115-01 OIL SEAL INSTALLER</p>  | |
| | <p>MB991714-01 BRAKE BOOSTER TOOL</p>  | <p>MB991380-01 OIL SEAL INSTALLER</p>  | | <p>MB991015-01 FRONT HUB OIL SEAL INSTALLER</p>  | |
| | <p>MB990955A-01 OIL SEAL INSTALLER</p>  | | | | |
| <p>MB991963 SUSPENSION BUSHING ARBOR</p>  | | <p>MB992236-01 INSTALLER CIRCLIP</p>  | | <p>MB991056-01 KNUCKLE ARM BRIDGE</p>  | |
| <p>MB991244-01 TRUNK LID TORSION BAR REMOVER/REPLACER</p>  | <p>MD998443-01 AUTO-LASH ADJUSTER HOLDER</p>  | <p>MB991367-01 SPANNER WRENCH</p>  | | | <p>MB990392-01 GAUGE TUBE</p>  |
| | <p>MIT27522 DRIVE PLATE</p>  | <p>MIT217212 PINS, 10MM SET</p>  | | | |
| | <p>MB990776-01 FRONT AXLE BASE</p>  | <p>MB991833-01 DRIVE SHAFT PULLER</p>  | | | |
| | | | <p>MB990211-2-01 ADAPTER COMPONENT OF MB990211-01 KIT</p>  | | |

ESSENTIAL TOOLS

| | | | | | |
|-------------------|-------------------|-------------------|-------------------|-------------------|-------------------|
| ↑ | ↑ | ↑ | ↑ | ↑ | ↑ |
| Qty. 1 D-30-06 | Qty. 7 D-30-06 | Qty. 4 D-30-06 | Qty. 1 D-30-06 | Qty. 3 D-30-04 | Qty. 1 D-30-04 |

DIVIDERS

DRAWER 4

MITSUBISHI

ESSENTIAL TOOL AUDIT — 2021

Dealer Code: _____

- Inspect tool drawer.
- Place a check mark on each tool located. Circle missing tools.
- Enter total price of missing tools, then initial "Drawer Completed."

| LOCATION | TOOL# | TOOL DESCRIPTION | UNIT PRICE | ORDER QTY |
|----------|----------------|---|------------|-----------|
| A1 | MB991244-01 | TRUNK LID TORSION BAR REMOVER/REPLACER | 138.81 | |
| A1 | MB991963 | SUSPENSION BUSHING ARBOR | 103.47 | |
| A2 | J-44372 | 5-60 LB PULL GAUGE | 112.26 | |
| B1 | MB990776-01 | FRONT AXLE BASE | 34.65 | |
| B2 | MIT27522 | DRIVE PLATE | 20.10 | |
| B3 | MD998443-01 | AUTO-LASH ADJUSTER HOLDER | 64.01 | |
| B4 | MB990955A-01 | OIL SEAL INSTALLER | 35.32 | |
| B5 | MB991714-01 | BRAKE BOOSTER TOOL | 96.55 | |
| B6 | MB990889 | REAR SUSPENSION BUSHING RING | 24.89 | |
| B7 | MB990800 | BALL JOINT DUST COVER INSTALLER | 42.39 | |
| B8 | MB991448-01 | BUSH REMOVER & INSTALLER BASE | 22.12 | |
| C1 | MB991833-01 | DRIVESHAFT PULLER | 64.32 | |
| C2 | MB991367-01 | SPANNER WRENCH | 106.03 | |
| C2 | MIT217212 | PINS, 10MM SET | 29.26 | |
| C2 | MIT217213 | PINS, 11MM SET | 28.91 | |
| C3 | MB992236-01 | INSTALLER, CIRCLIP | 33.96 | |
| C4 | MB991380-01 | OIL SEAL INSTALLER | 35.59 | |
| C5 | MB992050 | DELTA GLASS ADJUST BLOCK SET | 61.63 | |
| C5 | MB992053 | DOOR GLASS ADJUST BLOCK SET (BLACK/ PS24) | 120.19 | |
| C5 | MB992164 | DOOR GLASS ADJUST BLOCK SET (BLUE / PS28) | 146.68 | |
| D1 | *MB990211-2-01 | ADAPTER COMPONENT OF MB990211-01 KIT | 5.05 | |
| D2 | MB990211-01 | SLIDE HAMMER WITH ADAPTER KIT | 34.27 | |
| E1 | MB991056-01 | KNUCKLE ARM BRIDGE | 86.11 | |
| E2 | MB991015-01 | FRONT HUB OIL SEAL INSTALLER | 33.04 | |
| E3 | MB991115-01 | OIL SEAL INSTALLER | 24.13 | |
| E4 | MB990998-01 | FRONT HUB REMOVER/INSTALLER | 91.25 | |
| E4 | MB992867-01 | KNUCKLE ARM BRIDGE SPACER | 7.57 | |
| F1 | MB990392-01 | GAUGE TUBE | 76.79 | |
| F2 | MB990767-01 | END YOKE HOLDER | 53.61 | |
| F2 | MIT308239 | CRANK/CAMSHAFT PULLEY HOLDER PIN | 37.23 | |
| | FR01 | BLACK FOAM DRAWER LINER | 11.95 | |
| | D-30-04 | DIVIDER | 0.73 | |
| | D-30-06 | DIVIDER | 0.82 | |

Note: Components of a kit are included when ordering the kit number. *Component of a kit. All pricing is subject to change.

Drawer Completed: _____
Initial

Drawer Total Essential Tools: _____

DRAWER 5

MITSUBISHI

ESSENTIAL TOOL AUDIT — 2021

Dealer Code: _____

- Inspect tool drawer.
- Place a check mark on each tool located. Circle missing tools.

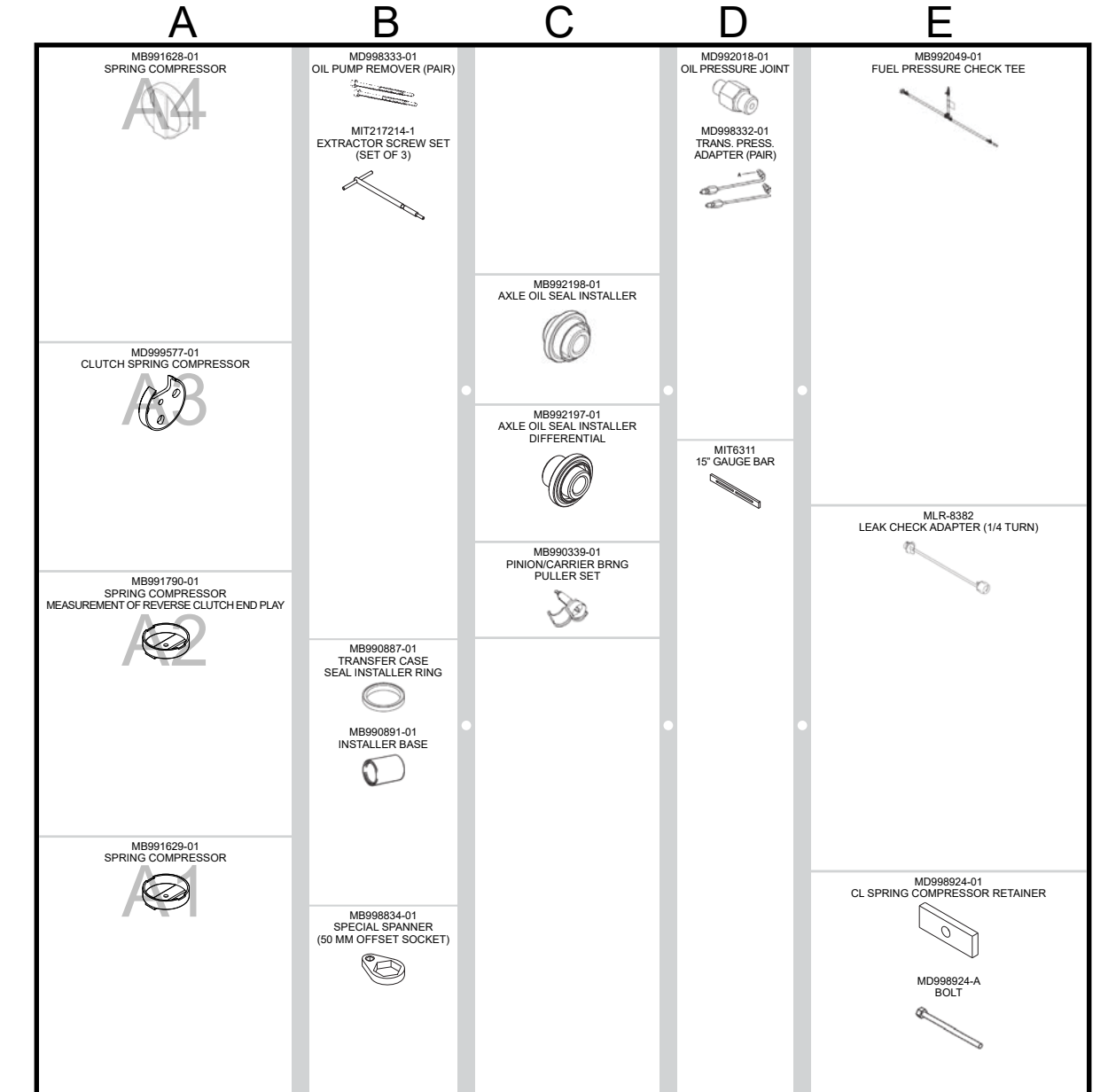

ESSENTIAL TOOLS

Qty. 3
D-30-08

Qty. 2
D-30-05

Qty. 3
D-30-06

Qty. 1
D-30-04

Qty. 2
D-30-09

DIVIDERS

DRAWER 5

MITSUBISHI

ESSENTIAL TOOL AUDIT — 2021

Dealer Code: _____

- Inspect tool drawer.
- Place a check mark on each tool located. Circle missing tools.
- Enter total price of missing tools, then initial "Drawer Completed."

| LOCATION | TOOL# | TOOL DESCRIPTION | UNIT PRICE | ORDER QTY |
|----------|-------------|--|------------|-----------|
| A1 | MB991629-01 | SPRING COMPRESSOR | 102.41 | |
| A2 | MB991790-01 | SPRING COMPRESSOR | 57.41 | |
| A3 | MD999577-01 | CLUTCH SPRING COMPRESSOR | 95.21 | |
| A4 | MB991628-01 | SPRING COMPRESSOR | 134.34 | |
| B1 | MD998834-01 | SPECIAL SPANNER (50 MM OFFSET SOCKET) | 79.02 | |
| B2 | MB990887-01 | TRANSFER CASE SEAL INSTALLER RING | 38.44 | |
| B2 | MB990891-01 | INSTALLER BASE | 95.93 | |
| B3 | MD998333-01 | OIL PUMP REMOVER (PAIR) | 33.81 | |
| B3 | MIT217214-1 | EXTRACTOR SCREW SET | 31.04 | |
| C1 | MB990339-01 | PINION/ CARRIER BRNG PULLER SET | 361.76 | |
| C2 | MB992197-01 | AXLE OIL SEAL INSTALLER - DIFFERENTIAL | 39.47 | |
| C3 | MB992198-01 | AXLE OIL SEAL INSTALLER | 95.09 | |
| D1 | MIT6311 | 15" GAUGE BAR | 378.53 | |
| D2 | MB992018-01 | OIL PRESSURE JOINT | 19.16 | |
| D2 | MD998332-01 | MIT211143 TRANS. PRESS. ADAPTER (PAIR) | 97.62 | |
| E1 | MD998924-01 | CL SPRING COMPRESSOR RETAINER | 11.63 | |
| E1 | MD998924-A | BOLT | 18.13 | |
| E2 | MLR-8382 | LEAK CHECK ADAPTER (1/4 TURN) | 73.33 | |
| E3 | MB992049-01 | FUEL PRESSURE CHECK TEE | 121.00 | |
| | FR01 | BLACK FOAM DRAWER LINER | 11.95 | |
| | D-30-04 | DIVIDER | 0.73 | |
| | D-30-05 | DIVIDER | 0.73 | |
| | D-30-06 | DIVIDER | 0.82 | |
| | D-30-08 | DIVIDER | 0.82 | |
| | D-30-09 | DIVIDER | 0.82 | |

Note: Components of a kit are included when ordering the kit number. *Component of a kit. All pricing is subject to change.

Drawer Completed: _____
Initial

Drawer Total Essential Tools: _____



















DRAWER 6

MITSUBISHI

ESSENTIAL TOOL AUDIT — 2021

Dealer Code: _____

- Inspect tool drawer.
- Place a check mark on each tool located. Circle missing tools.

| A | B | C | D |
|---|--|--|---|
| <p>MB991633-01 BAND ADJUSTER TOOL SET</p> <p>MB991693-01 COMPONENTS MB991634-01 COMPONENTS MB991635-01 COMPONENTS</p>  | <p>MB991789-01 SPRING COMPRESSOR</p>  | <p>MB992139-01 SPRING COMPRESSOR KIT</p>  <p>MB992139-01-1 COMPONENT OF MB992139-01</p> <p>MB992139-01-2 COMPONENT OF MB992139-01</p> | <p>J-51909 CVT LIFTING TOOL</p>  |
| <p>MD998350-01 BEARING INSTALLER</p>  | | | <p>J-8092 DRIVER HANDLE</p>  |
| <p>MB991630-01 CLUTCH SPRING COMPRESSOR</p>  | <p>MD998735-01 VALVE SPRING COMPRESSOR</p>  | | <p>J-52611 CHARGE PIPE CAP RELEASE TOOL</p>  |
| <p>MB992272-01 BEARING INSTALLER</p>  | | | <p>J-52082 CVT LIFTING FIXTURE</p>  |
| <p>MIT991445-01 BUSH REMOVER & INSTALLER BASE</p>  | | <p>J-52281 OUTPUT SEAL INSTALLER (FK-K2, CASE)</p>  | <p>J-38879-B FUEL TANK LOCK RING TOOL</p>  |
| <p>MIT991550 PUMP ADAPTER, 90 DEGREES</p> <p>MB991548-01 PUMP ADAPTER</p> <p>MB991549-01 HOSE ADAPTER</p> <p>MB990993-01 OIL PRESSURE GAUGE ADAPTER</p> <p>MB990994-01 OIL PRESSURE GAUGE ADAPTER</p>  | | <p>J-52282 OUTPUT SEAL INSTALLER (FK-K2, TC)</p>  <p>J-50818 CVT2 OIL PUMP SEAL INSTALLER</p>  | <p>J-45741-A TEST KIT, ABS WHEEL SENSOR</p>  |
| <p>MIT220433 FUEL PRESSURE TEST ADAPTER</p>  | | | |

ESSENTIAL TOOLS

Qty. 5
D-40-07

Qty. 1
D-40-08

Qty. 2
D-40-05

Qty. 5
D-40-07

DIVIDERS

DRAWER 6

MITSUBISHI

ESSENTIAL TOOL AUDIT — 2021

Dealer Code: _____

- Inspect tool drawer.
- Place a check mark on each tool located. Circle missing tools.
- Enter total price of missing tools, then initial "Drawer Completed."

| LOCATION | TOOL# | TOOL DESCRIPTION | UNIT PRICE | ORDER QTY |
|----------|----------------|-------------------------------------|------------|-----------|
| A1 | MB990993-01 | OIL PRESSURE GAUGE ADAPTER | 82.47 | |
| A1 | MB990994-01 | OIL PRESSURE GAUGE ADAPTER | 145.98 | |
| A1 | MB991548-01 | PUMP ADAPTER | 91.03 | |
| A1 | MB991549-01 | HOSE ADAPTER | 60.33 | |
| A1 | MIT991550 | PUMP ADAPTER, 90 DEGREES | 356.01 | |
| A2 | MB991445-01 | BUSH REMOVER & INSTALLER BASE | 74.00 | |
| A3 | MB992272-01 | BEARING INSTALLER | 243.81 | |
| A4 | MB991630-01 | CLUTCH SPRING COMPRESSOR | 60.87 | |
| A5 | MD998350-01 | BEARING INSTALLER | 33.04 | |
| A6 | MB991633-01 | BAND ADJUSTER TOOL SET | 269.85 | |
| A6 | *MB991634-01 | COMPONENT OF MB991633-01 | 62.15 | |
| A6 | *MB991635-01 | COMPONENT OF MB991633-01 | 137.43 | |
| A6 | *MB991693-01 | COMPONENT OF MB991633-01 | 67.00 | |
| B1 | MD998735-01 | VALVE SPRING COMPRESSOR | 135.52 | |
| B2 | MB991789-01 | SPRING COMPRESSOR | 124.73 | |
| C1 | MIT220433 | FUEL PRESSURE TEST ADAPTER | 31.51 | |
| C2 | J-52281 | OUTPUT SEAL INSTALLER (FK-K2, CASE) | 53.64 | |
| C2 | J-52282 | OUTPUT SEAL INSTALLER (FK-K2, TC) | 217.33 | |
| C3 | MB992139-01 | SPRING COMPRESSOR KIT | 549.00 | |
| C3 | *MB992139-01-1 | COMPONENT OF MB992139-01 | 239.00 | |
| C3 | *MB992139-01-2 | COMPONENT OF MB992139-01 | 239.00 | |
| D1 | J-45741-A | TEST KIT, ABS WHEEL SENSOR | 94.11 | |
| D2 | J-38879-B | FUEL TANK LOCK RING TOOL | 82.31 | |
| D3 | J-52082 | CVT LIFTING FIXTURE | 155.50 | |
| D4 | J-52611 | CHARGE PIPE ADAPTER KIT | 72.36 | |
| D5 | J-8092 | DRIVER HANDLE | 518.07 | |
| D6 | J-51909 | CVT LIFTING TOOL | 71.81 | |
| | FR01 | BLACK FOAM DRAWER LINER | 11.95 | |
| | D-40-07 | DIVIDER | 1.12 | |
| | D-40-08 | DIVIDER | 1.12 | |
| | D-40-10 | DIVIDER | 1.12 | |

Note: Components of a kit are included when ordering the kit number. *Component of a kit. All pricing is subject to change.

Drawer Completed: _____
Initial

Drawer Total Essential Tools: _____

DRAWER 7

MITSUBISHI

ESSENTIAL TOOL AUDIT — 2021

Dealer Code: _____

- Inspect tool drawer.
- Place a check mark on each tool located. Circle missing tools.

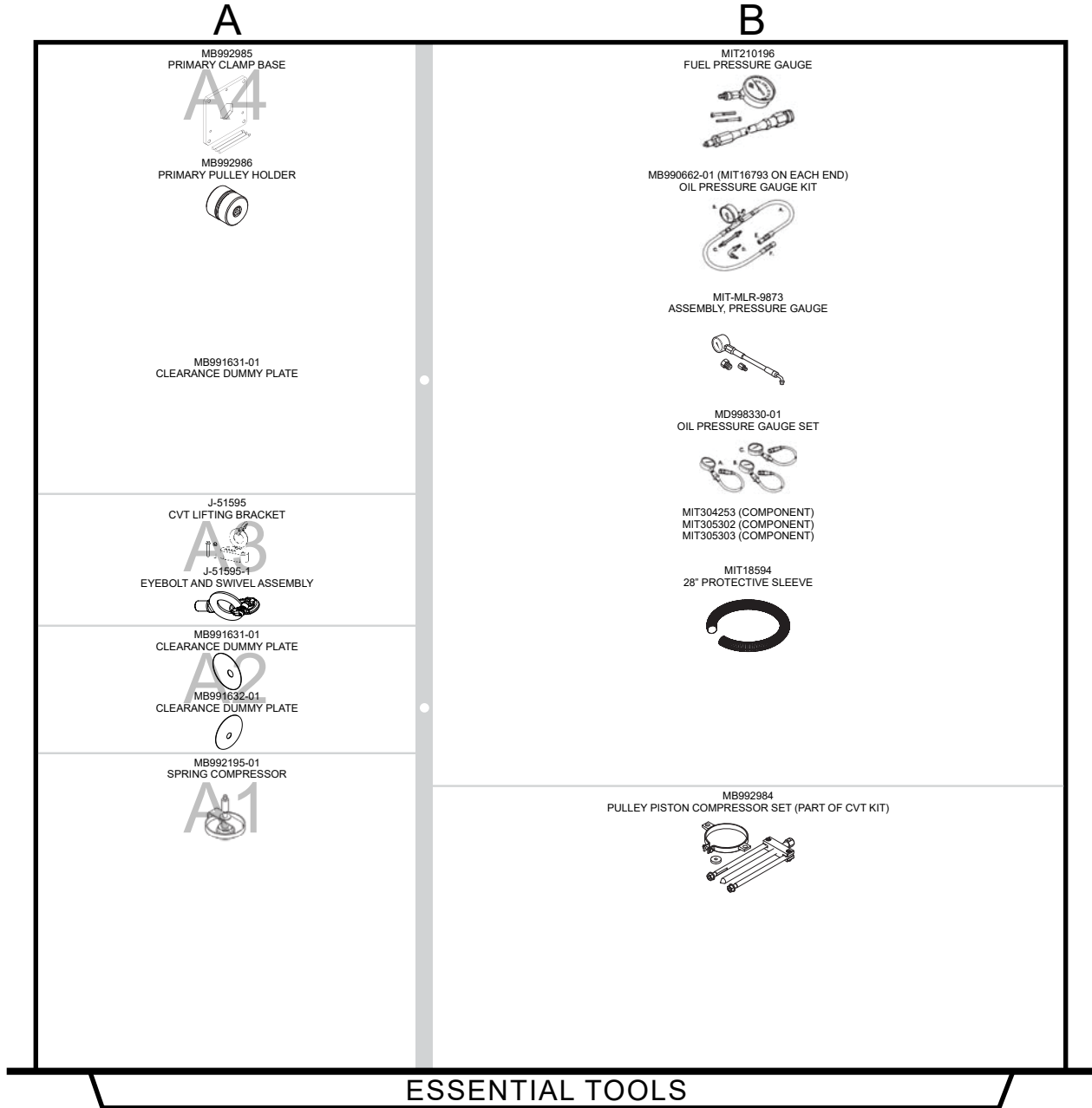

↑
 Qty. 7
 D-20-04

↑
 Qty. 3
 D-20-05

DIVIDERS

DRAWER 7

MITSUBISHI

ESSENTIAL TOOL AUDIT — 2021

Dealer Code: _____

- Inspect tool drawer.
- Place a check mark on each tool located. Circle missing tools.
- Enter total price of missing tools, then initial "Drawer Completed."

| LOCATION | TOOL# | TOOL DESCRIPTION | UNIT PRICE | ORDER QTY |
|----------|--------------|---|------------|-----------|
| A1 | MB992195-01 | SPRING COMPRESSOR | 499.73 | |
| A2 | MB991631-01 | CLEARANCE DUMMY PLATE | 85.99 | |
| A2 | MB991632-01 | CLEARANCE DUMMY PLATE | 121.04 | |
| A3 | J-51595 | CVT LIFTING BRACKET | 36.10 | |
| A3 | J-51595-1 | EYEBOLT AND SWIVEL ASSEMBLY | 32.70 | |
| A4 | MB992985 | PULLEY CLAMP BASE | 199.29 | |
| A4 | MB992986 | PRIMARY PULLEY HOLDER | 38.27 | |
| B1 | MB992984 | PULLEY PISTON COMPRESSOR SET (PART OF CVT KIT) | 177.18 | |
| B2 | MIT210196 | FUEL PRESSURE GAUGE | 73.28 | |
| B2 | MB990662-01 | OIL PRESSURE GAUGE KIT | 258.13 | |
| B2 | MIT-MLR-9873 | ASSEMBLY, PRESSURE GAUGE | 113.65 | |
| B2 | MD998330-01 | OIL PRESSURE GAUGE SET | 135.14 | |
| B2 | *MIT304253 | PRESSURE GAUGE (COMPONENT OF MB998330-01) | 41.03 | |
| B2 | *MIT305302 | PRESSURE GAUGE (COMPONENT OF MB998330-01) | 39.85 | |
| B2 | *MIT305303 | PRESSURE GAUGE (COMPONENT OF MB998330-01) | 40.65 | |
| B2 | MIT18594 | 28" PROTECTIVE SLEEVE | 4.65 | |
| | FR01 | BLACK FOAM DRAWER LINER | 11.95 | |
| | D-50-12 | DIVIDER | 1.64 | |
| | D-50-20 | DIVIDER | 2.38 | |

Note: Components of a kit are included when ordering the kit number. *Component of a kit. All pricing is subject to change.

Drawer Completed: _____
Initial

Drawer Total Essential Tools: _____

IN SHOP TOOLS

MITSUBISHI

ESSENTIAL TOOL AUDIT — 2021

Dealer Code: _____

- Inspect all tools not stored in the cabinet.
- Place a check mark on each tool located.
- Enter total price of missing tools, then initial "Section Completed" line.

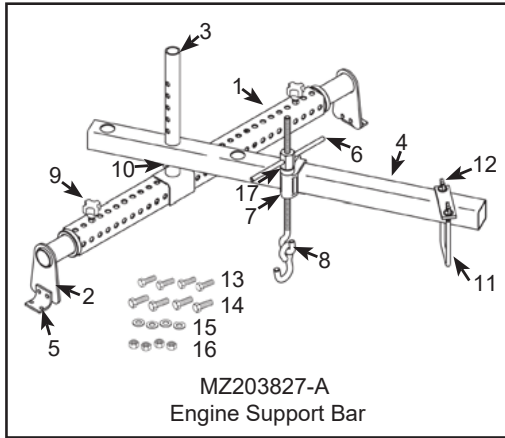

MZ203827-A Kit

| ITEM NO. | PART NO. | DESCRIPTION | UNIT PRICE | ORDER QTY |
|----------|---------------|----------------------------|------------|-----------|
| | MZ203827-A | ENGINE SUPPORT BAR | 478.19 | |
| 1 | *MZ203827-A-1 | SUPPORT CROSSBAR | 66.06 | |
| 2 | *MZ203827-A-2 | SUPPORT LEG | 61.92 | |
| 3 | *MZ203827-A-3 | LEG SUPPORT BRACKET | 80.48 | |
| 4 | *MZ203827-A-4 | SECONDARY BAR | 62.86 | |
| 5 | *MZ203827-A-5 | BRACKET | 51.22 | |
| 6 | *MLR-8534-14 | HANDLE | 28.84 | |
| 7 | *MLR-8534-13 | BRACKET | 69.17 | |
| 8 | *MLR-8534-11 | HOOK ASSEMBLY | 33.24 | |
| 9 | *214632 | KNOB | 10.47 | |
| 10 | *J-28467-9 | QUICK RELEASE PIN | 5.34 | |
| 11 | *531316 | "U" BRACKET | 3.95 | |
| 12 | *531970 | PLATE | 3.86 | |
| 13 | *208562 | METRIC CAP SCREW, 5 PIECES | 1.00 | |
| 14 | *10049-PK5 | CAP SCREW (3/8") | 4.95 | |
| 15 | *10231 | WASHER (3/8"), 5 PIECES | 4.95 | |
| 16 | *10204 | NUT, 5 PIECES | 4.95 | |
| 17 | *217011 | THRUST BALL BEARING | 10.70 | |

*Indicates component of MZ203827-A Kit

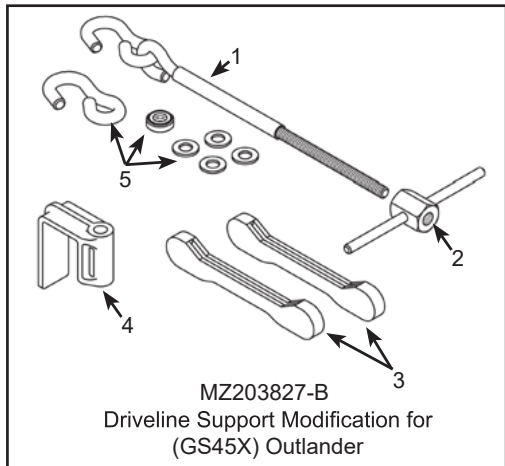

MZ203827-B Kit

| ITEM NO. | PART NO. | DESCRIPTION | UNIT PRICE | ORDER QTY |
|----------|---------------|------------------------|------------|-----------|
| | MZ203827-B | SUPPORT MOD. FOR GS45X | 198.19 | |
| 1 | *MZ203827-B-2 | HOOK ASSEMBLY | 17.18 | |
| 2 | *MZ203827-B-4 | HANDLE | 15.25 | |
| 3 | *MZ203827-B-1 | PROTECTIVE SLEEVE | 76.04 | |
| 4 | *MLR-8534-13 | BRACKET | 69.17 | |
| 5 | *MZ203827-B-3 | HOOK, WASHER & BRG. | 19.65 | |

*Indicates component of MZ203827-B Kit

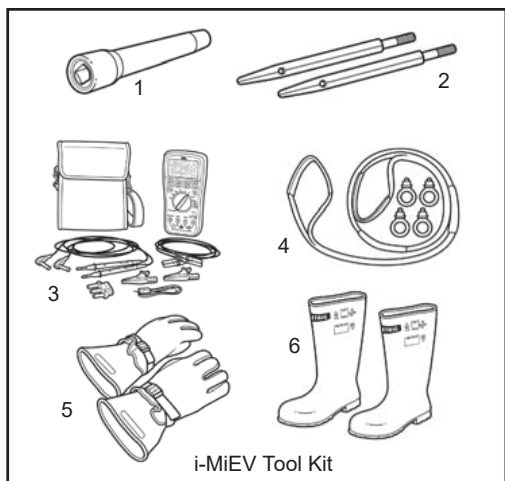

i-MiEV Kit

| ITEM NO. | PART NO. | DESCRIPTION | UNIT PRICE | ORDER QTY |
|----------|-------------|-------------------------------|------------|-----------|
| 1 | MB992337 | SOCKET, INSULATED | 146.33 | |
| 2 | MB992327 | GUIDE, EV BATTERY | 51.30 | |
| 3 | MB992343-01 | SLING KIT, BATTERY LIFT | 143.45 | |
| 4 | MB992648-01 | GLOVE SET, ELECTRIC INSULATED | 107.26 | |
| 5 | MIT992659 | BOOT, ELECTRIC INSULATED | 179.38 | |
| 6 | 3990 | KIT, HYBRID METER | 279.96 | |
| 7 | 561987 | STORAGE BAG, i-MiEV TOOLS | 67.88 | |

*Items listed in the i-MiEV Tool Kit are only Essential for certified i-MiEV dealers.

Section Completed: _____
Initial

Column Total \$ _____

IN SHOP TOOLS

MITSUBISHI

ESSENTIAL TOOL AUDIT — 2021

Dealer Code: _____

- Inspect all tools not stored in the cabinet.
- Place a check mark on each tool located.
- Enter total price of missing tools, then initial "Section Completed" line.

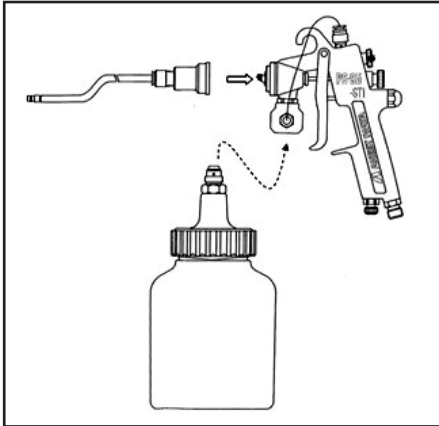

Anti-Corrosion Application Kit

| ITEM NO. | PART NO. | DESCRIPTION | UNIT PRICE | ORDER QTY |
|--|-------------|---------------------|------------|-----------|
| 1 | *MZ341023EX | Rust Stop Spray Gun | 441.17 | |
| 2 | *MIT577640 | Spray Gun Regulator | 44.39 | |
| *Indicates component of Anti-Corrosion Application Kit | | | | |

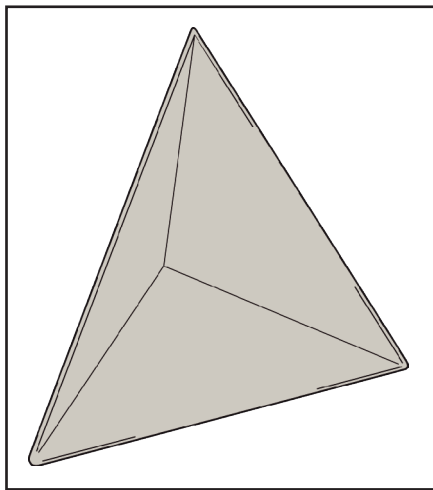

Anti-Corrosion Application Kit

| ITEM NO. | PART NO. | DESCRIPTION | UNIT PRICE | ORDER QTY |
|---|------------|-----------------|------------|-----------|
| 1 | *MB99RT01V | BSW/RCTA Tester | 40.00 | |
| *Indicates component of Blind Spot Warning Tool Kit | | | | |

Section Completed: _____
Initial

Column Total \$ _____

ELECTRICAL SYSTEM

MITSUBISHI

ESSENTIAL TOOL AUDIT — 2021

Dealer Code: _____

- Inspect all tools not stored in the cabinet.
- Place a check mark on each tool located.
- Enter total price of missing tools, then initial "Section Completed" line.

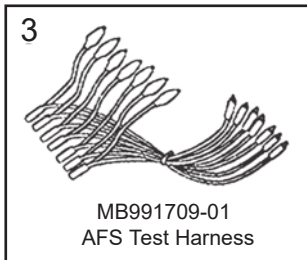
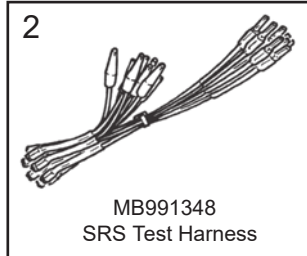
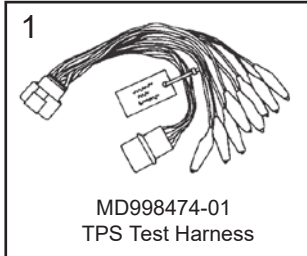

| ITEM NO. | PART NO. | DESCRIPTION | UNIT PRICE | ORDER QTY |
|----------|-------------|----------------|------------|-----------|
| 1 | MD998474-01 | HARNESS | 40.61 | |
| 2 | MB991348 | HARNESS | 63.21 | |
| 3 | MB991709-01 | HARNESS | 45.34 | |
| 4 | MB991865 | RESISTOR | 12.45 | |
| 5 | MB991866 | RES. HARNESS | 37.43 | |
| 6 | MB991884 | RES. HARNESS | 59.52 | |
| 7 | MD998478-01 | TPS TEST HARN. | 45.01 | |
| 8 | 165-EXP-830 | BATT. TESTER | 1272.00 | |
| 9 | MIT47305 | RF DETECTOR | 223.39 | |
| 10 | MIT280220 | EMIS. TESTER | 799.76 | |
| | *MLR-6890A | | 104.00 | |
| | *MLR-6922 | | 73.33 | |

*Indicates component of a tool kit

Brake System

| PART NO. | DESCRIPTION | UNIT PRICE | ORDER QTY |
|----------------|------------------------------|------------|-----------|
| 38-92-BASE-IBT | ON-CAR BRAKE LATHE & TROLLEY | 8,175.00 | |
| 38-50-5ADP | 5 ADAPTER PACKAGE | 1,967.00 | |
| 38-50-ACC | ACCESSORY KIT | 493.00 | |

Section Completed: _____
Initial

Column Total \$ _____

ELECTRICAL SYSTEM

MITSUBISHI

ESSENTIAL TOOL AUDIT — 2021

Dealer Code: _____

- Inspect all tools not stored in the cabinet.
- Place a check mark on each tool located.
- Enter total price of missing tools, then initial "Section Completed" line.

Multi-Use Tester III STV Kit

| ITEM NO. | PART NO. | DESCRIPTION | UNIT PRICE | ORDER QTY |
|----------|---------------|--|------------|-----------|
| 1 | FZG1MK2 | PANASONIC TOUHPAD MK2 | 2,499.00 | |
| 2 | MB992744 | VEHICLE COMMUNICATION INTERFACE (VCI-LITE) | 1,146.00 | |
| 3 | MB992745V | MUT-III MAIN HARNESS A-L | 164.00 | |
| 4 | MB992746V | MUT-III MAIN HARNESS B-L | 238.00 | |
| 5 | RRAR1MBR108GL | 90 DEGREE USB CABLE | 20.00 | |
| 6 | MB991855 | 12-13 PIN ADAPTER | 12.26 | |
| 7 | 3MSJ3781 | VCI LITE VELCRO | 2.50 | |

Tool Cabinet Organization System

| ITEM NO. | PART NO. | DESCRIPTION | UNIT PRICE | ORDER QTY |
|----------|-----------------|-----------------------------|------------|-----------|
| 1 | MIT533127 | STANLEY VIDMAR CABINET | 2,240.88 | |
| 2 | *MIT533127-UPD | SPECIAL TOOL STORAGE UPDATE | 163.21 | |
| 3 | *MIT533127-UPD1 | SPECIAL TOOL STORAGE UPDATE | 60.73 | |

Section Completed: _____
Initial

Column Total \$ _____