



Special Tools Storage Cabinet Master Index

April 2024

Table of Contents

	<i>Page #</i>
Special Tool List and Location Index.....	2-8
Drawer Reference	9-35
Overhead Tools	36
Overhead Tools - J-50135-B Engine Support Kit.....	38
Shop Tools	40

NOTE: As of this update and printing, all New Retailer Kit tools issued from 2009 through current will fit in these tool boxes. These are what are required as per the franchise agreement. New Subaru Retailer Kits will not have tools listed as OPTIONAL.

Optional tools are not required, but were issued prior to this publication and have been allocated a space in the tool management system.

OPTIONAL TOOLS					
165-EXP-1000S-CW	24082AA080	398852100	898938600	98299FC000	J-45443
165-GR8-1100-SUB	24082AA130RA	41099AA011	899014100	98299FC020	J-45697
18231AA000	24082AA290	498037000	922431000	98299FC030	J-47606
18231AA020	28099PA040	498037100	926040000	98299FC040	J-49863-1
18233AA000	28099PA060	498187200	926250000	98299FC041	J-50135-A
18251AA000	28099PA070	498427000	926340001	98299FE000	SOA625336
18251AA040	28399SA000	498627000	926390001	98299FE020	SOA638654
18253AA000	34099FA030	498677000	926480000	98299FE030	
18258AA000	34099FA100	498787100	927100000	98299PA000	
18329AA000	34099FA110	498937100	927430000	98299PA011	
18332AA020	34099FA120	499097300	927440000	98299PA020	
18356AA000	34099FA130	499207200	927450000	98299SA030	
18361AA000	34099FA140	499207300	927460000	98299SA060	
18482AA010RA	34099PA000	499207400	927490000	J-33984-A	
18679AA000	34099PA030	499207400-A	927580000	J-34274	
18854AA000	34099PA040	499587300	927650000	J-41336	
20099AE030	34099PA050	499587400	927660000	J-41510	
20099PA000	34099PA060	499767000	927760000	J-42908	
22771AA030	34099PA070	499767500	927820000	J-43979	
22775AA050	34199AE050	499787100	98299AE000	J-44159	
22783AA001	34199AG030	499827000	98299AG000	J-44369	
22784AA000	34199AG050	499990120	98299AG030	J-44903	
24036AA010	398744300	697-95-0070	98299AG050	J-44959	

These optional tools are also indicated as OPTIONAL in the manual by being highlighted in Gray.



Special Tool List and Location Index

TOOL #	TOOL DESCRIPTION	DRAWER #	TOOL #	TOOL DESCRIPTION	DRAWER #
2002	HYBRID BATTERY LIFTING CRANE (Hybrid Retailers Only)	SHOP	09952-04010-SUB	SLIDE ARM	24
96-0124	BUMPER BRACKET TOOL (SOA807001T)	1	09954-04010-SUB	ARM 25	24
01813-00062	10MM INSULATED WRENCH	5	09955-04061-SUB	CLAW NO. 6	24
09260-39020-01	INJECTOR SEAL INSTALLER KIT	8	09958-04011-SUB	HOLDER	24
09308-00010-SUB	OIL SEAL PULLER	25	09960-20010-SUB	BALL JOINT SET	O/H
09350-07110-SUB	OIL SEAL REPLACER	24	09989-00020-SUB	DIGITAL ATTACHMENT	25
09506-42020-SUB	TRANSFER BEARING RACE REPLACER	24	11813-00003-SUB	INSULATED TOOL KIT	5
09520-01011-SUB	DRIVE ATTACHMENT	24	12281-38150	ENGINE HANGER BRACKET (Part of J-50135-B Kit)	O/H
09521-02010-SUB	ROD NO. 1	24	165-DCA-8000-SUB	SUBARU DIAGNOSTIC BATTERY CHARGER	SHOP
09521-02040-SUB	WEIGHT NO. 1	24	165-DSS-5000-SUB	MIDTRONICS HAND HELD BATTERY CHARGER	SHOP
09521-02060-SUB	GRIP	24	165-EXP-1000S-CW	MIDTRONICS HAND HELD BATTERY TESTER Replaced by 165-DSS-5000-SUB	SHOP
09521-02070-SUB	NUT NO. 1	24	165-GR8-1100-SUB	GR8 DIAGNOSTIC BATTERY CHARGER Replaced by 165-DCA-8000-SUB	SHOP
09570-24011-SUB	REMOVER AND REPLACER (DIFFERENTIAL MOUNT CUSHION)	32	1587 FC	FLUKE MEGA OHM METER	O/H
09570-48010-SUB	REMOVER AND REPLACER (DIFFERENTIAL MOUNT CUSHION)	32	18231AA000	WRENCH, CAM SPROCKET	6
09616-00011-SUB	STEERING WORM BEARING ADJUSTING SOCKET	24	18231AA020	WRENCH, CAM SHAFT SPROCKET	7
0961600020	SOCKET, STEERING PRELOAD	18	18233AA000	PLIERS, PISTON PIN	7
09617-24011-SUB	STEERING RACK WRENCH	24	18251AA000	ADJUSTER, VALVE GUIDE	6
09710-28031-SUB	REPLACER SET	24	18251AA040	ADJUSTER, VALVE GUIDE	7
09729-00170-SUB	EXTENSION WRENCH 17	25	18251AA050	VALVE GUIDE ADJUSTER	7
09756-48050-SUB	SUB HARNESS NO. 2	25	18251AA060	VALVE GUIDE ADJUSTER	7
09812-00010-SUB	DOOR HINGE SET BOLT WRENCH (12MM)	24	18252AA000	SOCKET, CRANKSHAFT	7
09830-01010-SUB	BOLT	24	18253AA000	GUIDE, PISTON PIN	7
09830-01020-SUB	NUT	24	18258AA000	INSTALLER, ADJUSTER SPRING	7
09830-01040-SUB	WASHER	24	18258AA001	INSTALLER, ADJUSTER SPRING	7
09830-01050-SUB	SPACER NO. 1	24	18261AA010	SEAL TOOL, VALVE GUIDE	7
09830-01060-SUB	SPACER NO. 2	24	18270AA020	SOCKET	7
09870-52010-SUB	TELEVISION CAMERA ADJUSTMENT TARGET	O/H	18270AA040	SOCKET	7
09870-60040-SUB	REFLECTOR C	26	18270KA010	TORX SOCKET, E16	15
09870-61100-SUB	TARGET BOARD NO. 1	O/H	18270KA020	SOCKET, TORX	2
09870-62200-SUB	TARGET SHEET NO. 2	O/H	18271AA030	INJECTOR SEAL INSTALLER	8
09893-00020-SUB	BATTERY GUIDE PIN	24	18271AA040	INJECTOR SEAL SIZER	8
09893-07020-SUB		32	18283AA000	WRENCH	20
09893-42040-SUB	BATTERY HANGER	24	18283AA010	EPF REMOVAL	20
09893-72020-SUB	RUBBER PAD SET	24	18329AA000	REPLACER, SHIM	7
09950-00020-SUB	BEARING REMOVER	25	18332AA020	OIL FILTER WRENCH	6
09950-00030-SUB	BEARING REMOVER ATTACHMENT	25	18333AA000	PISTON PIN REMOVER ADAPTER	2
09951-00330-SUB	REPLACER 33	25	18334AA000	PIN SET	7
09951-00720-SUB	REPLACER 72	24	18334AA020	PIN SET, PULLEY WRENCH	7
09951-00890-SUB	REPLACER 89	24	18334AA030	PIN SET, PULLEY WRENCH, INTAKE	7
09951-04010-SUB	HANGER 150	24	18334AA040	ADAPTERS, CAM PIN BOLT	7
			18350AA000	REMOVER/INSTALLER, BUSHING	7

Special Tool List and Location Index

TOOL #	TOOL DESCRIPTION	DRAWER #	TOOL #	TOOL DESCRIPTION	DRAWER #
18354AA000	HOLDER, VALVE ROCKER	7	18664AA000	BASE	16
18355AA000	PULLEY WRENCH	7	18665AA000	HOLDER	16
18356AA000	REMOVER, DI INJECTOR	8	18666AA000	HOLDER	16
18356AA001	REMOVER, DI INJECTOR	8	18667AA010	HOLDER, DRIVE PIN	3
18356AA010	INJECTER REMOVER	8	18667AA020	HOLDER, DRIVE PINION	14
18360AA020	HANGER BRACKET H-6	8	18668AA000	PUNCH, MAINSHAFT	15
18360AA040	ENGINE HANGAR (Part of J-50135-B Kit)	O/H	18669AA000	PUNCH, DRIVEN SHAFT	15
18361AA000	WRENCH, CAMSHAFT	6	18670AA000	PUNCH, DRIVE PIN	15
18362AA050	ADAPTER, CHAIN REMOVER (Part of J-53038 Kit)	15	18671AA000	GUIDE, OIL SEAL	15
18362AA060	LH #2 INJECTOR SPACER	8	18671AA020	GUIDE, OIL SEAL	6
18362AA070	RH #1 INJECTOR SPACER	8	18671AA020	GUIDE, OIL SEAL	6
18362AA140	ADAPTER, TRANSFER CLUTCH OIL PRESSURE	2	18672AA000	GUIDE, CLIP	14
18363AA060	BOLT, CHAIN COVER REMOVER (Part of J-53038 Kit)	15	18675AA000	DIFFERENTIAL SIDE SEAL INSTALLER	22
18371AA000	RELEASE, QUICK-CONNECT	7	18676AA020	WRENCH	1
18460AA030	HARNES, DI TEST	23	18679AA000	ADJUSTER	1
18460AA040	CVT CHECK HARNES	23	18680AA000	HOLDER, GEAR	1
18460AA050	CVT CHECKBOARD HARNES	O/H	18680AA010	HOLDER, GEAR	1
18460AA120	CHECKBOARD HARNES	O/H	18680AA020	HOLDER, GEAR	15
18460AA150	CHECKBOARD HARNES	O/H	18681AA000	ADAPTER, PRESSURE GAGE, CVT	1
18460AA180	CHECKBOARD HARNES	O/H	18681AA010	ADAPTER, PRESSURE GAGE, CVT	1
18460AA190	CHECKBOARD HARNES	O/H	18681AA040	ADAPTER, PRESSURE GAGE	1
18471AA000	ADAPTER, FUEL PIPE	7	18681AA060	OIL PRESSURE GAUGE ADAPTER	1
18482AA010RA	CARTRIDGE, SMII 2001-2006	20	18682AA000	INSTALLER, HUB SEAL	22
18620AA000	ASSEMBLY, WRENCH	14	18720AA000	REMOVER ASSEMBLY, 3RD	15
18621AA000	WRENCH ASSEMBLY, DRIVE PIN	14	18722AA000	REMOVER ASSEMBLY, 6TH	14
18630AA000	RETAINER WRENCH	16	18723AA000	REMOVER ASSEMBLY, DRIVEN GEAR	15
18630AA010	WRENCH, CP-RETAINER	3	18750AA010	HOLDER, TORQUE CONVERTER	2
18631AA000	HANDLE	14	18754AA000	REMOVER, BUSHING	15
18632AA000	SET(4), STAND PIN	14	18757AA000	REMOVER, STRAIGHT PIN	15
18632AA010	STAND ASSEMBLY	O/H	18758AA000	PULLER	15
18632AA020	STAND ASSEMBLY, TRANSMISSION	8	18762AA000 or 18762AA001	COMPRESSOR	3
18632AA030	ENGINE POSITIONER	8	18763AA000	SHAFT, COMPRESSOR	2
18651AA000	INSTALLER, MAIN SHAFT	15	18765AA000	SUPPORT, COMPRESSOR	2
18654AA000	INSTALLER, DRIVEN SHAFT	2	18766AA000	SUPPORT, PULLER	15
18657AA000	INSTALLER, SEAL	15	18767AA000	REMOVER, BEARING	2
18657AA010	INSTALLER, OIL SEAL	13	18767AA010	BEARING PULLER	2
18657AA030	INSTALLER, OIL SEAL	23	18767AA020	BEARING PULLER	2
18657AA040	INSTALLER, OIL SEAL	7	18801AA000	OIL PRESSURE GAGE, CVT	23
18658AA020	FRONT DIFFERENTIAL RETAINING WRENCH	23	18831AA000	GAUGE	16
18662AA010	SOCKET, HYPOID	15	18852AA000	WRENCH, TORQUE	O/H
18663AA000	SOCKET, COVER OIL PUMP, T40	13	18853AA000	GAUGE, HEIGHT	O/H
			18854AA000	GAUGE	2
			20099AE030	SUSPENSION DAMPER REMOVER	O/H

Special Tool List and Location Index

TOOL #	TOOL DESCRIPTION	DRAWER #	TOOL #	TOOL DESCRIPTION	DRAWER #
20099PA000	STRUT LOCK NUT WRENCH	21	34199AE050	REMOVER	18
20099PA010	BUSHING REPLACER	21	34199AG000	BOSS D	18
20299AG000	REMOVER, CONTROL ARM BUSHING	21	34199AG010	INSTALLER	18
20299AG010	BASE, CONTROL ARM BUSHING	21	34199AG020	GUIDE	18
20399FG000	SOCKET 14	21	34199AG030	GUIDE	18
22771AA030	SUBARU SELECT MONITOR II	O/H	34199AG050	GUIDE	18
22775AA050	PC CABLE W/PRINTER SOFTWARE	20	34199AG060	GUIDE, PAS SEALING RING	17
22783AA001	SELECT MONITOR II RETRO CABLE	20	34199AG070	FORMER	18
22784AA000	PRINTOUT SOFTWARE	20	34199AG080	FORMER	18
24036AA010	JUMPER WIRES	9	34199AG090	INSTALLER	18
24082AA080	CARTRIDGE, SSMII/NSM 1996-1997	20	34199AG100	POWER STEERING TEST HARNESS	11
24082AA130RA	CARTRIDGE 1998 - 2000	20	34199AJ030	BACKLASH LOCKING WRENCH	18
24082AA290	CARTRIDGE, SSMII/NSM IMMOBILIZER 2005	20	34199AJ040	BACKLASH HOLDING WRENCH	18
28099AC000	AXLE BOOT CLAMP PLIERS	22	34199AJ060	PINION NUT WRENCH	18
28099PA010	FRONT HUB SUPPORT	O/H	34199FE000	INSTALLER AND REMOVER	18
28099PA040	HUB REMOVER	O/H	34199FE040	INSTALLER	17
28099PA060	REAR HUB SUPPORT	22	34199XA000	INSTALLER	18
28099PA070	HUB SEAL INSTALLERS	22	34199XA010	GUIDE	17
28099PA100	DRIVE SHAFT REMOVER	22	34199XA020	FORMER	18
28399SA000	DRIVE SHAFT REMOVER	22	34199XA030	INSTALLER	17
28399SA010	PROTECTOR, AXLE SHAFT	22	34199XA060	SEAL REMOVER	17
28499SG000	SPECIAL PLATE A (Part of J-53014 Kit)	13	34299CA000	WRENCH, PINION NUT	15
28499SG010	SPECIAL PLATE SPACER B (Part of J-53014 Kit)	13	398177700	INSTALLER	14
28499SG020	BOLT(S) (Part of J-53014 Kit)	13	398487700	DRIFT, GE CARRIER SIDE BEARING	13
303-F070-6	ENGINE HOOK (Part of J-50135-B Kit)	O/H	398497701	PILOT	13
34099AC010	ADAPTER HOSE A	18	398527700	O/SL & PULLER	13
34099AC020	ADAPTER HOSE B	18	398643600	GAUGE	13
34099FA030	INSTALLER	17	398744300	GUIDE, PISTON	4
34099FA060	PUNCH	17	398852100	INSTALLER, OIL	6
34099FA100	STEERING GEAR STAND BASE	17	399780104	WEIGHT BACKLASH	16
34099FA110	RACK HOUSING SEAL INSTALLER	17	41099AA011	TRANSMISSION POWERTRAIN SUPPORT	O/H
34099FA120	VALVE HOUSING BEARING SEAL TL	17	41099AA012	ENGINE SUPPORT BRACKET	O/H
34099FA130	VALVE HOUSING SEAL INSTALLER	17	41099AA020	ENGINE SUPPORT	7
34099FA140	RACK HOUSING SEAL REMOVER	17	41099AC000	ASSEMBLY, ENGINE SUPPORT	7
34099PA000	PISTON RING SEAL INSTALLER	17	41099AJ000-A	ENGINE SUPPORT BRACKET H-6	8
34099PA010	INNER RACK SEAL REMOVER	18	41099AJ010-A	ENGINE SUPPORT BRACKET H-6	8
34099PA030	INNER RACK SEAL INSTALLER	17	41099AJ130	BRACKET, ENGINE POSITIONING	8
34099PA040	INNER RACK SEAL PROTECTOR	17	41099YC001	TRANSMISSION SUPPORT	O/H
34099PA050	OIL SEAL INSTALLER	17	41399CA000	BUSHING, R&R RH	23
34099PA060	PINION BEARING RECEIVER	17	41399CA050	BUSHING, R&R LH	23
34099PA070	PINION BEARING REMOVER	17	41399FG001	REAR SUBFRAME BUSHING TOOL	22
34099PA100	PINION LOCKNUT WRENCH	18	42099AE000	QUICK CONNECTOR, S/T	7
34199AE030	SEAL INSTALLER	18	42099CA000	WRENCH, FUEL TANK RING	8
			42099CC000	SPECIAL TOOL, FUEL PUMP	O/H

Special Tool List and Location Index

TOOL #	TOOL DESCRIPTION	DRAWER #	TOOL #	TOOL DESCRIPTION	DRAWER #
42099FL000	FUEL PUMP RING TOOL	8	499497000	TORX BIT, BIT 40	6
42099FL010	FUEL TANK RING WRENCH (Hybrid Retailers Only)	4	499575400	GAGE, BEARING HEIGHT	1
498037000	CLIP INSTALLER	6	499577000	GAGE, TRANSFER	13
498037100	CAMSHAFT PLUG SEAL INSTALLER	6	499585500	GUIDE, OIL SEAL	7
498057300	INSTALLER, OIL SEAL	1	499585700	GUIDE, OIL SEAL	8
498077000	REMOVER, DRIVEN GEAR 5TH	1	499587100	INSTALLER, OIL SEAL	1
498077300	REMOVER	13	499587200	INSTALLER, OIL SEAL	3
498077400	SYNCHRONIZER CONE REMOVER	13	499587300	CAMSHAFT OIL SEAL INSTALLER	6
498077600	REMOVER	1	499587400	FRONT MAIN SEAL INSTALLER	6
498175500	DIFFERENTIAL TOOL	14	499587500	INSTALLER, OIL SEAL	6
498187200	SHIM REPLACER	6	499587600	INSTALLER, OIL SEAL	6
498247001	MAGNET BASE	1	499587700	CAMSHAFT OIL SEAL INSTALLER	6
498247100	DIAL GAUGE	13	499597000	GUIDE, OIL SEAL	6
498255400	PLATE, MAGNET BASE	13	499718000	REMOVER, VALVE SPRING	6
498277200	FLYWHEEL STOPPER	6	499718300	VALVE GUIDE SPRING COMP. ADAPTER	6
498427000	STOPPER, DRIVE PINION	13	499737000	REDUCTION GEAR ASSEMBLY PULLER	1
498427100	STOPPER, DRIVE PINION	13	499737100	PULLER SET	2
498447100	DIFFERENTIAL SIDE SEAL INSTALLER	1	499747100	GUIDE, CLUTCH DISC	1
498515700	REMOVER	13	499755602	COMPRESSOR	1
498517000	REPLACER, DRIVE PINION	13	499757002	INSTALLER	13
498627000	SEAT LOW AND REY	1	499765900	REAMER, VALVE GUIDE	7
498627100	SEAT COMPRESSOR	1	499767000	ADJUSTER, VALVE GUIDE	13
498677000	COMPRESSOR BAND SERVO	1	499767500	VALVE GUIDE ADJUSTER	6
498747300	PISTON RING COMPRESSOR	4	499767700	ADJUSTER, VALVE GUIDE, INTAKE	6
498787100	STOPPER, MAIN SHAFT	13	499767800	ADJUSTER, VALVE GUIDE, EXHAUST	6
498897700	CVT OIL PRESSURE ADAPTER HOSE	1	499787000	WRENCH ASSEMBLY	13
498937000	HOLDER, TRANSMISSION	13	499787100	WRENCH, ASSEMBLY DRIVE PINION	13
498937100	HOLDER, DRIVE PINION	15	499787500	PRELOAD ADAPTER WENCH	1
498937110	SHAFT HOLDER	15	499787700	WRENCH	1
499017100	GUIDE-PISTON PIN	1	499827000	PRESS, SPEEDOMETER, O/S	6
499097300	REMOVER ASSEMBLY PISTON PIN	6	499857000	REMOVER, ASSEMBLY DRIVE GEAR	13
499097600	PISTON PIN REMOVER	2	499877000	INSTALLER, RACE 4-5	13
499097700	PISTON PIN REMOVER	6	499917500	GAGE, ASSEMBLY DRV PINION	14
499207100	WRENCH-CP SPKT	1	499927100	HANDLE, TRANSMISSION SHAFT	14
499207200	CAM GEAR WRENCH	6	499977100	WRENCH, CRANK PULLEY	8
499207300	CAMSHAFT HOLDER ASSEMBLY	6	499977400	WRENCH, CRANK PULLEY	8
499207400-A	CAMSHAFT SPROCKET WRENCH	8	499977500	HOLDING TOOL, CAM SPROCKET	7
499247300	INSTALLER DRV PINION	16	499987300	SOCKET WRENCH	7
499247400	INSTALLER	1	499990120	WRENCH	8
499267300	PIN, REMOVER	1	61299CA000	DOOR ALIGNER, REGULATOR	20
499277100	INSTALLER, BUSH 1 & 2	13	61299CA010	DOOR ALIGNER, REGULATOR	20
499277200	INSTALLER, BUSH	1	697-95-0070	EVAP SYSTEM PRESSURE PUMP	O/H
			697-95-0073	EVAP SYSTEM PRESSURE TESTER (Supersedes 697-95-0070)	O/H

Special Tool List and Location Index

TOOL #	TOOL DESCRIPTION	DRAWER #	TOOL #	TOOL DESCRIPTION	DRAWER #
697-96-0103	EVAP ADAPTER PLUG	O/H	927460000	INSTALLER, OIL SEAL	22
697-96-0104	EVAP PASS THROUGH PLUG	O/H	927490000	INSTALLER	17
73099SG000	CONDENSER, SPECIAL WRENCH	20	927580000	REMOVER	18
73499XA00A	REMOVER, HIGH PRESSURE AC	20	927640000	INSTALLER, B	22
73499XA01A	REMOVER, LOW PRESSURE AC	20	927650000	INSTALLER	17
81911-FL010-SUB	CONNECTOR HOLDER	32	927660000	GUIDE	17
81911-FL030-SUB	CONNECTOR HOLDER	24	927680000	INSTALLER & REMOVER	17
81911-FL040-SUB	CONNECTOR HOLDER	24	927720000	INSTALLER & REMOVER	21
81911-FL050-SUB	CONNECTOR HOLDER	32	927760000	SOCKET, STRUT MOUNT	21
86399XC000	PERIMETER CAMERA CALIBRATION CHART	O/H	927820000	BASE TUBE	21
87599VA000	iCHART	O/H	9804AA000	CONNECTOR PIN TOOL WIRE HARNESS	12
87599YC001	iCHART ADA CAMERA	O/H	98299AE000	HARNESS, TEST (K)	12
87692AN01A	RAB SENSOR BRACKET ALIGNMENT TOOL	1	98299AG000	TEST HARNESS	9
87692AN00A	RAB REMOVAL TOOL	1	98299AG010	TEST HARNESS V	12
87692VA000	BUMPER BRACKET TOOL (Supersedes to SOA807001T and is replaced by 96-0124)	1	98299AG030	TEST HARNESS	12
898938600	HOLDER	6	98299AG040	TEST HARNESS Y	12
899014100	PISTON PIN PRESS	7	98299AG050	TEST HARNESS Z	12
899524100	PULLER	3	98299AG060	TEST HARNESS D	12
899580100	INSTALLER	6	98299AG070	TEST HARNESS AG	9
899714110	REMOVER, CAM GEAR	2	98299AG080	TEST HARNESS, AIR BAG	10
899858600	RETAINER	14	98299AG090	TEST HARNESS AI	11
899864100	INSTALLER	13	98299AL000	TEST HARNESS	12
899884100	HOLDER	14	98299AL010	TEST HARNESS	12
90119 14120	ENGINE BRACKET BOLT (Part of J-50135-B Kit)	O/H	98299AL020	TEST HARNESS	12
922431000	HOUSING INSTALLER	21	98299AL030	TEST HARNESS	12
925091000 and 925091000-A	BAND TIGHTENER, AXLE BOOT (Supersedes to OTC 4623)	21	98299AN000	TEST HARNESS AB, MODULE DIAGNOSTICS	O/H
925711000-A	POWER STEERING PRESSURE TESTER	19	98299AN010	TEST HARNESS BA, DOOR SENSOR DIAGNOSTICS	12
926040000	SOCKET, O2 SENSOR	17	98299CA000	TEST HARNESS AD/AR	10
926200000	STAND, GEARBOX	19	98299CC000	TEST HARNESS BH	O/H
926230000	SPANNER	17	98299CC010	TEST HARNESS BI	O/H
926250000	GUIDE (P/S)	17	98299CA010	TEST HARNESS	10
926340001	WRENCH	17	98299CA020	TEST HARNESS AD/AR/AT	10
926390001	COVER ASSEMBLY	17	98299FA030-1	AIR BAG TEST HARNESS	12
926420000	PLUG, INSTALLER	17	98299FC000	SUBARU AIRBAG HARNESS	11
926470000	AXLE SHAFT PULLER	O/H	98299FC010	SUBARU AIRBAG HARNESS	11
926480000	PLATE AXLE SHAFT PULLER	20	98299FC020	SUBARU AIRBAG HARNESS	11
927080000	PULLER, HUB	22	98299FC030	A, ADAPTER	10
927100000	PULLER, BEARING	22	98299FC040	AIR BAG TEST HARNESS	11
927430000	STAND, R HOUSING	22	98299FC041	HARNESS, I2 TEST AIR BAG	9
927440000	PULLER, REAR WHEEL BEARING	22	98299FE000	HARNESS, TEST L	11
927450000	INSTALLER, REAR HUB	22	98299FE020	HARNESS, TEST M	11
			98299FE030	HARNESS, TEST (R)	9



































Special Tool List and Location Index

TOOL #	TOOL DESCRIPTION	DRAWER #	TOOL #	TOOL DESCRIPTION	DRAWER #
98299FG000	TEST HARNESS -AJ	10	J-47606	KIT, SUBARU GLOBAL TERMINAL WIRING	O/H
98299FG010	TEST HARNESS AD-K	11	J-47673	WEIGHT TOOL, PASSENGER	SHOP
98299FJ030	TEST HARNESS, AIR BAG	11	J-49755	FUEL ALCOHOL TESTER	6
98299FL010	TEST HARNESS BA	11	J-49863	PRESSURE GAGE, FUEL	23
98299FL020	ODS HARNESS, TEST BB	11	J-49863-1	FUEL CONNECTION TOOL	23
98299FL030	ODS HARNESS, TEST BC (2 each)	11	J-50135	ENGINE BRIDGE (Part of J-50135-B Kit)	O/H
98299PA000	AIR BAG TEST HARNESS A	10	J-50135-6	NEW ENGINE STANCHIONS (LEGS) (Part of J-50135-B Kit)	O/H
98299PA011	AIR BAG HARNESS	10	J-50135-A	ENGINE SUPPORT KIT (See page 34)	O/H
98299PA020	AIR BAG TEST HARNESS C	10	J-50135-B	ENGINE SUPPORT KIT (See page 34)	O/H
98299PA030	AIR BAG DEPLOYMENT HARNESS	9	J-50136	ENGINE HANGER BRACKET H4 ENGINE (Part of J-50135-B Kit)	O/H
98299PA040	AIR BAG RESISTOR	10	J-50137	ENGINE SAFETY SLING AND SHACKLE (Part of J-50135-B Kit)	O/H
98299SA000	HARNESS, TEST (N)	10	J-50552	PIN SET, PULLEY WRENCH	7
98299SA010	HARNESS, TEST (D)	10	J-50553	PISTON RING COMPRESSOR	4
98299SA020	HARNESS, TEST (P)	9	J-50972	TRUNK TORSION BAR	O/H
98299SA030	HARNESS, TEST (E)	11	J-50984	COMPRESSOR, PISTON RING	4
98299SA040	HARNESS, TEST (Q)	10	J-51003	PISTON RING COMPRESSOR	4
98299SA060	HARNESS, TEST	10	J-51311	HEV KIT	O/H
98299XA000	HARNESS, AB TEST	18	J-51443 or VT36-0002	TPMS TESTER	O/H
98299XA010	HARNESS, AC TEST	19	J-51658	ENGINE BRIDGE ADAPTER (Part of J-50135-B Kit)	O/H
98299XA020	HARNESS, AD TEST	19	J-51972	CAM COVER GUIDE PINS	2
98299XA030	HARNESS, AE TEST	19	J-51973	CRANK SEAL INSTALLATION TOOL	3
98299XC000	HARNESS, BD TEST	O/H	J-52715	HYBRID BATTERY SLINGS (Hybrid Retailers Only)	SHOP
99099AL000	BRAKE SEAL TOOL	22	J-53014	REAR HUB PULLER KIT	13
99099FL000	TORSION BAR TOOL	23	J-53038	CASE COVER REMOVAL KIT	15
99804AA000	CONNECTOR PIN TOOL WIRE HARNESS	12	SOA321105	WRENCH, WINDOW	3
99804-AN030-SUB	REPAIR TOOL	24	SOA321113	BLIND SPOT RADAR REFLECTOR (see 96-0124)	1
J-28467-93A	SUPPORT NUT (Part of J-28467-125A Kit)	O/H	SOA625333	CLUTCH SPRING COMPRESSOR	3
J-28467-99	HOLD DOWN BOLT (Part of J-28467-125A Kit)	O/H	SOA625336	GAUGE PLATE	15
J-28467-125A	ENGINE SUPPORT FIXTURE ADAPTERS	O/H	SOA626234	OIL SEAL INSTALLER	2
EN-49245-SUB	INSTALLER/SIZER, INJECTOR SEAL	8	SOA629389	DRIVE PINION INSTALLER	20
J-33984-A	RADIATOR PRESSURE ADAPTS	8	SOA638654	CONNECTOR REMOVERS	20
J-34274	OIL FILTER WRENCH	O/H	SOA639715-A	PRESSURE GAUGE & ADAPTER SET	O/H
J-39401-4	NUTS, 6MM RECESSED	10	SOA814001T	RELAY PLIERS	9
J-39401-B	SIR DEPLOYMENT FIXTURE	O/H			
J-41336	RADIATOR ADAPTER	8			
J-41510	BELL HOUSING BOLT TORX BIT	1			
J-42908	CAM SPROCKET HOLDER/UNLOADER	8			
J-43979	VALVE SHIM POSITIONING TOOL	7			
J-44159	VALVE SHIM STORAGE CASE	O/H			
J-44369	REAR SUSPENSION BUSHING KIT	O/H			
J-44903	ADAPTER, FUEL CAP TEST	8			
J-44959	BIT, T-70 TORX	2			
J-45443	CAM SPROCKET HOLDER	8			
J-45697	HUB REMOVER/REPLACER KIT	O/H			

Drawer Reference

DRAWER 1

- | | |
|--|---|
| <input type="checkbox"/> 96-0124 BUMPER BRACKET TOOL | <input type="checkbox"/> 499017100 GUIDE-PISTON PIN |
| <input type="checkbox"/> 18676AA020 WRENCH | <input type="checkbox"/> 499207100 WRENCH-CP SPKT |
| <input checked="" type="checkbox"/> 18679AA000 ADJUSTER | <input type="checkbox"/> 499247400 INSTALLER |
| <input type="checkbox"/> 18680AA000 HOLDER, GEAR | <input type="checkbox"/> 499267300 PIN, REMOVER |
| <input type="checkbox"/> 18680AA010 HOLDER, GEAR | <input type="checkbox"/> 499277200 INSTALLER, BUSHING |
| <input type="checkbox"/> 18681AA000 ADAPTER, PRESSURE GAGE, CVT | <input type="checkbox"/> 499575400 GAUGE BEARING HEIGHT |
| <input type="checkbox"/> 18681AA010 ADAPTER, PRESSURE GAGE, CVT | <input type="checkbox"/> 499587100 INSTALLER, OIL SEAL |
| <input type="checkbox"/> 18681AA040 ADAPTER, PRESSURE GAGE, CVT | <input type="checkbox"/> 499737000 REDUCTION GEAR ASSEMBLY PULLER |
| <input type="checkbox"/> 18681AA050 CVT ADAPTER HOSE | <input type="checkbox"/> 499747100 GUIDE, CLUTCH DISC |
| <input type="checkbox"/> 18681AA060 OIL PRESSURE GAUGE ADAPTER | <input type="checkbox"/> 499755602 COMPRESSOR |
| <input type="checkbox"/> 41399CA170 BRZ CARRIER BOLT | <input type="checkbox"/> 499787500 PRELOAD ADAPTER WRENCH |
| <input type="checkbox"/> 498057300 INSTALLER, OIL SEAL | <input type="checkbox"/> 499787700 WRENCH |
| <input type="checkbox"/> 498077000 REMOVER, DRIVEN GEAR 5TH | <input type="checkbox"/> 87692AN01A RAB SENSOR BRACKET ALIGNMENT TOOL |
| <input type="checkbox"/> 498077600 REMOVER | <input type="checkbox"/> 87692AN00A RAB REMOVAL TOOL |
| <input type="checkbox"/> 498247001 MAGNET BASE | <input type="checkbox"/> J-41510 BELL HOUSING BOLT TORX BIT |
| <input type="checkbox"/> 498447100 DIFF SIDE SEAL INSTALLER | |
| <input checked="" type="checkbox"/> 498627000 SEAT, LOW AND REY | |
| <input type="checkbox"/> 498627100 SEAT COMPRESSOR | |
| <input type="checkbox"/> 498677000 COMPRESSOR BAND SERVO | |
| <input type="checkbox"/> 498897700 CVT OIL PRESSURE ADAPTER HOSE | |

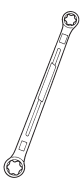
<p>499277200 INSTALLER, BUSH</p>  <p>96-0124 BUMPER BRACKET TOOL (WSM # 87692VA00 and SOA807001)</p>  <p>87692AN01A RAB SENSOR BRACKET ALIGNMENT TOOL</p>  <p>87692AN00A RAB REMOVAL TOOL</p>  <p>499247400 INSTALLER</p>  <p>498447100 DIFFERENTIAL SIDE SEAL INSTALLER</p>  <p>498057300 INSTALLER, OIL SEAL</p> 	<p>498627100 SEAT COMPRESSOR</p>  <p>498077600 REMOVER</p>  <p>498077000 REMOVER, DRIVEN GEAR 5TH</p>  <p>499747100 GUIDE, CLUTCH DISC</p> 	<p>499737000 REDUCTION GEAR ASSEMBLY PULLER</p>  <p>499587100 INSTALLER, OIL SEAL</p>  <p>498627000 SEAT, LOW AND REY</p>  <p>498247001 MAGNET BASE</p> 	<p>41399CA170 BRZ CARRIER BOLT</p>  <p>499207100 WRENCH-CP SPKT</p>  <p>498677000 COMPRESSOR BAND SERVO</p> 	<p>499575400 GAUGE BRG HEIGHT</p>  <p>18681AA050 CVT ADAPTER HOSE</p>  <p>499017100 GUIDE-PISTON PIN</p> 	<p>18681AA000 ADAPTER, PRESSURE GAUGE, CVT</p>  <p>18681AA010 ADAPTER, PRESSURE GAUGE, CVT</p>  <p>18681AA040 ADAPTER, PRESSURE GAUGE, CVT</p>  <p>18681AA060 ADAPTER, PRESSURE GAUGE, CVT</p>  <p>498897700 CVT OIL PRESSURE ADAPTER HOSE</p>  <p>18690AA010 HOLDER, GEAR</p>  <p>499787700 WRENCH</p>  <p>499787500 PRELOAD ADAPTER WRENCH</p>  <p>499755602 COMPRESSOR</p> 	<p>499267300 PIN, REMOVER</p>  <p>J-41510 BELL HOUSING BOLT TORX BIT</p>  <p>18680AA000 HOLDER, GEAR</p>  <p>18679AA000 ADJUSTER</p>  <p>18676AA020 WRENCH</p> 
--	---	--	---	---	---	--

NOTE: GRAY HIGHLIGHTED TOOLS ARE NO LONGER ESSENTIAL.

Drawer Reference

DRAWER 2

- 18270KA020 SOCKET, TORX
- 18333AA000 PISTON PIN REMOVER ADAPTER
- 18362AA140 ADAPTER, TRANSFER CLUTCH OIL PRESSURE
- 18654AA000 INSTALLER, DRIVEN SHAFT
- 18750AA010 HOLDER, TORQUE CONVERTER
- 18763AA000 SHAFT, COMPRESSOR
- 18765AA000 SUPPORT, COMPRESSOR
- 18767AA000 REMOVER, BEARING
- 18767AA010 BEARING PULLER
- 18767AA020 BEARING PULLER
- 18854AA000 GAUGE
- 499097600 PISTON PIN REMOVER
- 499737100 PULLER SET
- 899714110 REMOVER, CAM GEAR
- J-44959 BIT, T-70 TORX
- J-51972 CAM COVER GUIDE PINS
- SOA626234 OIL SEAL INSTALLER

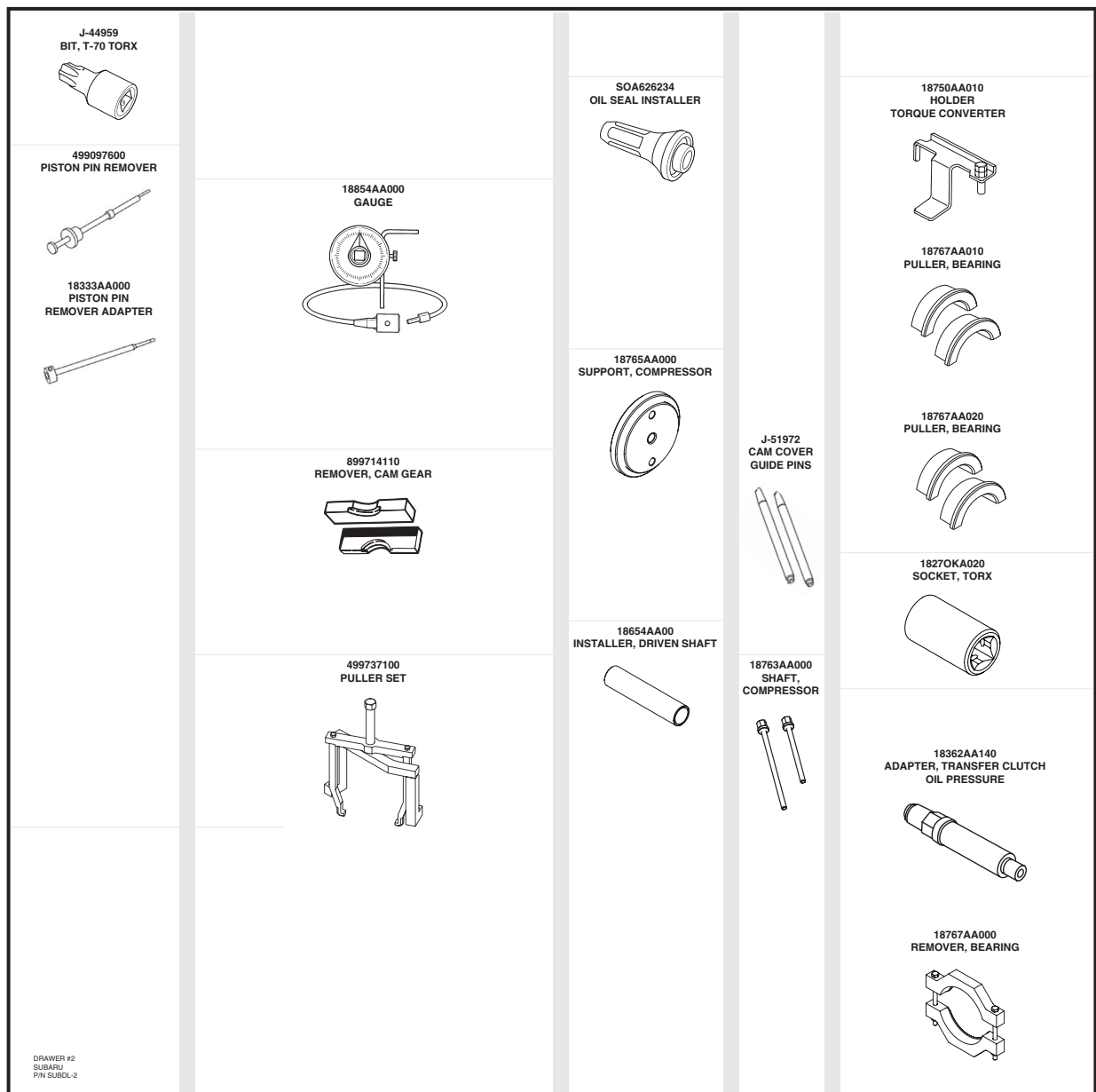





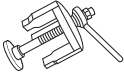

NOTE: GRAY HIGHLIGHTED TOOLS ARE NO LONGER ESSENTIAL.

Drawer Reference

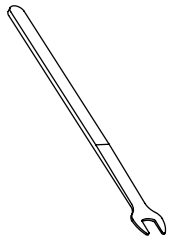
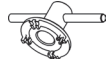
DRAWER 3

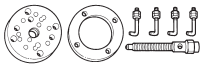
- 18630AA010 WRENCH, CP-RETAINER
- 18667AA010 HOLDER, DRIVE PIN
- 18762AA000 or 18762AA001 COMPRESSOR
- 499587200 INSTALLER, OIL SEAL
- 899524100 PULLER
- J-51973 CRANK SEAL INSTALLATION TOOL
- SOA321105 WRENCH, WINDOW
- SOA625333 CLUTCH SPRING COMPRESSOR

<p>SOA625333 CLUTCH SPRING COMPRESSOR</p> 	<p>J-51973 CRANK SEAL INSTALLATION TOOL</p> 
<p>18762AA000 or 18762AA001 COMPRESSOR</p> 	<p>SOA321105 WRENCH, WINDOW</p> 
<p>18630AA010 WRENCH, CP-RETAINER</p> 	<p>18667AA010 HOLDER, DRIVE PIN</p> 
<p>899524100 PULLER</p> 	<p>499587200 INSTALLER, OIL SEAL</p> 

NOTE: GRAY HIGHLIGHTED TOOLS ARE NO LONGER ESSENTIAL.

Drawer Reference

DRAWER 4

- 398744300 GUIDE, PISTON
- 42099FL010 FUEL TANK RING WRENCH
- 498747300 COMPRESSOR, PISTON RING
- J-50553 COMPRESSOR, PISTON RING
- J-50984 COMPRESSOR, PISTON RING
- J-51003 COMPRESSOR, PISTON RING

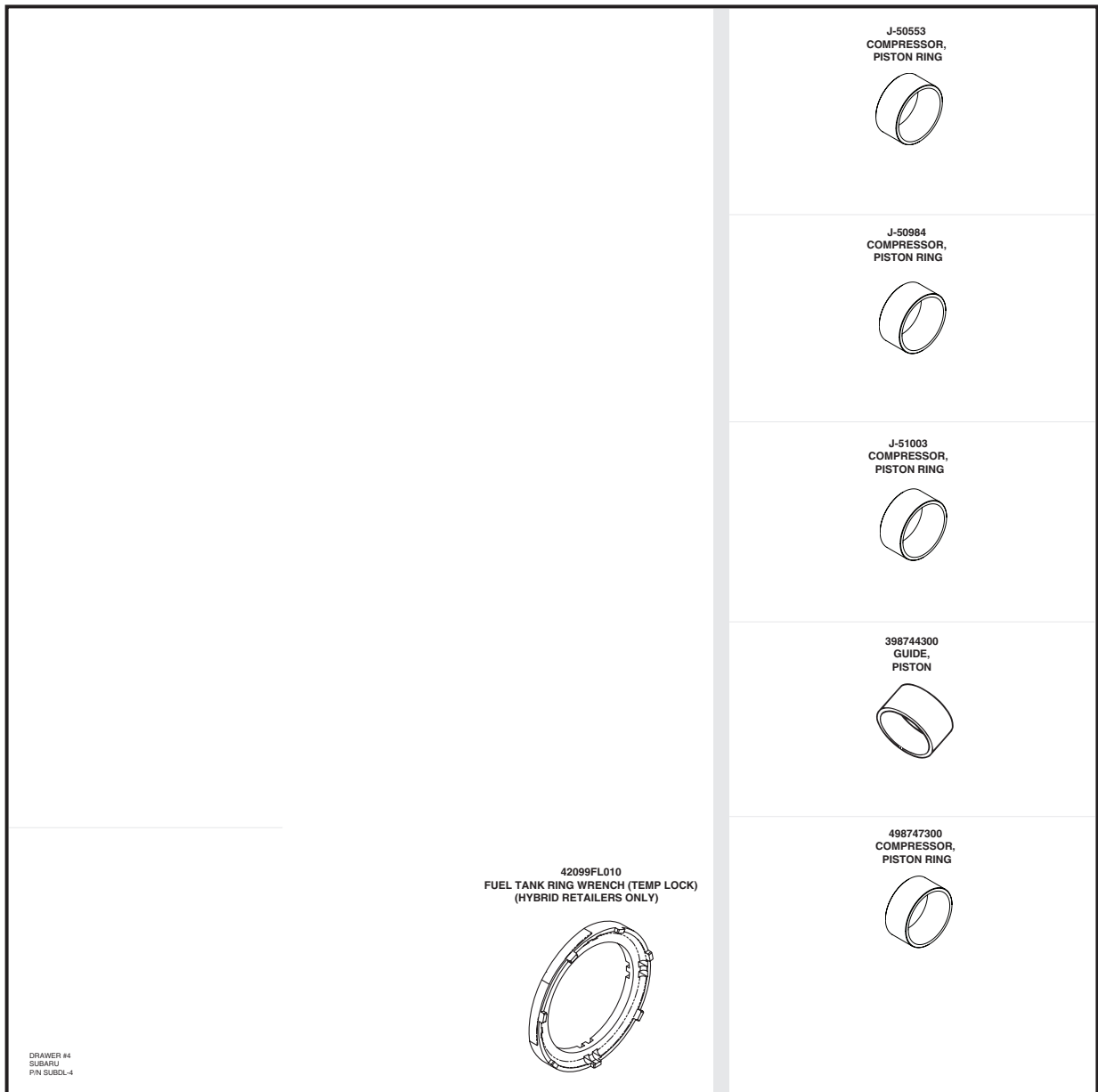

NOTE: GRAY HIGHLIGHTED TOOLS ARE NO LONGER ESSENTIAL.

Drawer Reference

DRAWER 5

- 01813-00062 10MM WRENCH
- 11813-00003-SUB INSULATED TOOL KIT

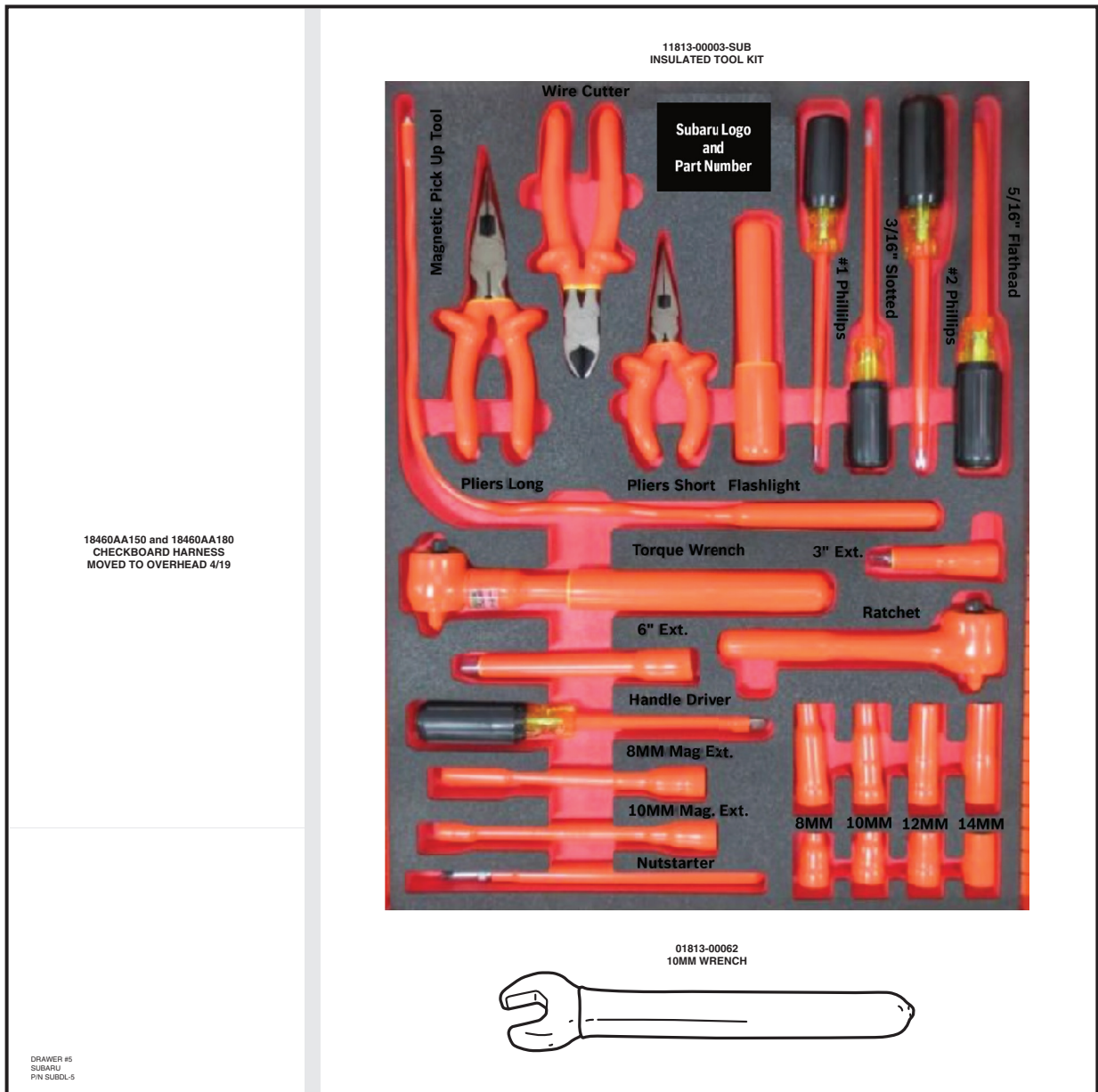

NOTE: GRAY HIGHLIGHTED TOOLS ARE NO LONGER ESSENTIAL.

Drawer Reference

DRAWER 6

- | | |
|---|--|
| <input type="checkbox"/> 18231AA000 WRENCH, CAM SPROCKET | <input type="checkbox"/> 499597000 GUIDE, OIL SEAL |
| <input type="checkbox"/> 18251AA000 ADJUSTER, VALVE GUIDE | <input type="checkbox"/> 499718000 REMOVER, VALVE SPRING |
| <input type="checkbox"/> 18332AA020 OIL FILTER WRENCH | <input type="checkbox"/> 499718300 VALVE SPRING COMPRESSOR ADAPTER |
| <input type="checkbox"/> 18361AA000 WRENCH, CAMSHAFT | <input type="checkbox"/> 499767500 VALVE GUIDE ADJUSTER |
| <input type="checkbox"/> 18671AA020 GUIDE, OIL SEAL | <input type="checkbox"/> 499767700 VALVE GUIDE ADJUSTER-INTAKE |
| <input type="checkbox"/> 398852100 INSTALLER, OIL | <input type="checkbox"/> 499767800 VALVE GUIDE ADJUSTER-EXHAUST |
| <input type="checkbox"/> 498037000 CLIP INSTALLER | <input type="checkbox"/> 499827000 PRESS, SPEEDOMETER, O/S |
| <input type="checkbox"/> 498037100 CAMSHAFT PLUG SEAL INSTALLER | <input type="checkbox"/> 898938600 HOLDER |
| <input type="checkbox"/> 498187200 SHIM REPLACER | <input type="checkbox"/> 899580100 INSTALLER |
| <input type="checkbox"/> 498277200 FLYWHEEL STOPPER | <input type="checkbox"/> J-49755 FUEL ALCOHOL TESTER |
| <input type="checkbox"/> 499097300 REMOVER ASSEMBLY PISTON PIN | |
| <input type="checkbox"/> 499097700 PISTON PIN REMOVER | |
| <input type="checkbox"/> 499207200 CAM GEAR WRENCH | |
| <input type="checkbox"/> 499207300 CAMSHAFT HOLDER ASSEMBLY | |
| <input type="checkbox"/> 499497000 TORX PLUS BIT T4 | |
| <input type="checkbox"/> 499587300 CAMSHAFT SEAL INSTALLER | |
| <input type="checkbox"/> 499587400 FRONT MAIN SEAL INSTALLER | |
| <input type="checkbox"/> 499587500 OIL SEAL INSTALLER | |
| <input type="checkbox"/> 499587600 OIL SEAL INSTALLER | |
| <input type="checkbox"/> 499587700 CAMSHAFT SEAL INSTALLER | |

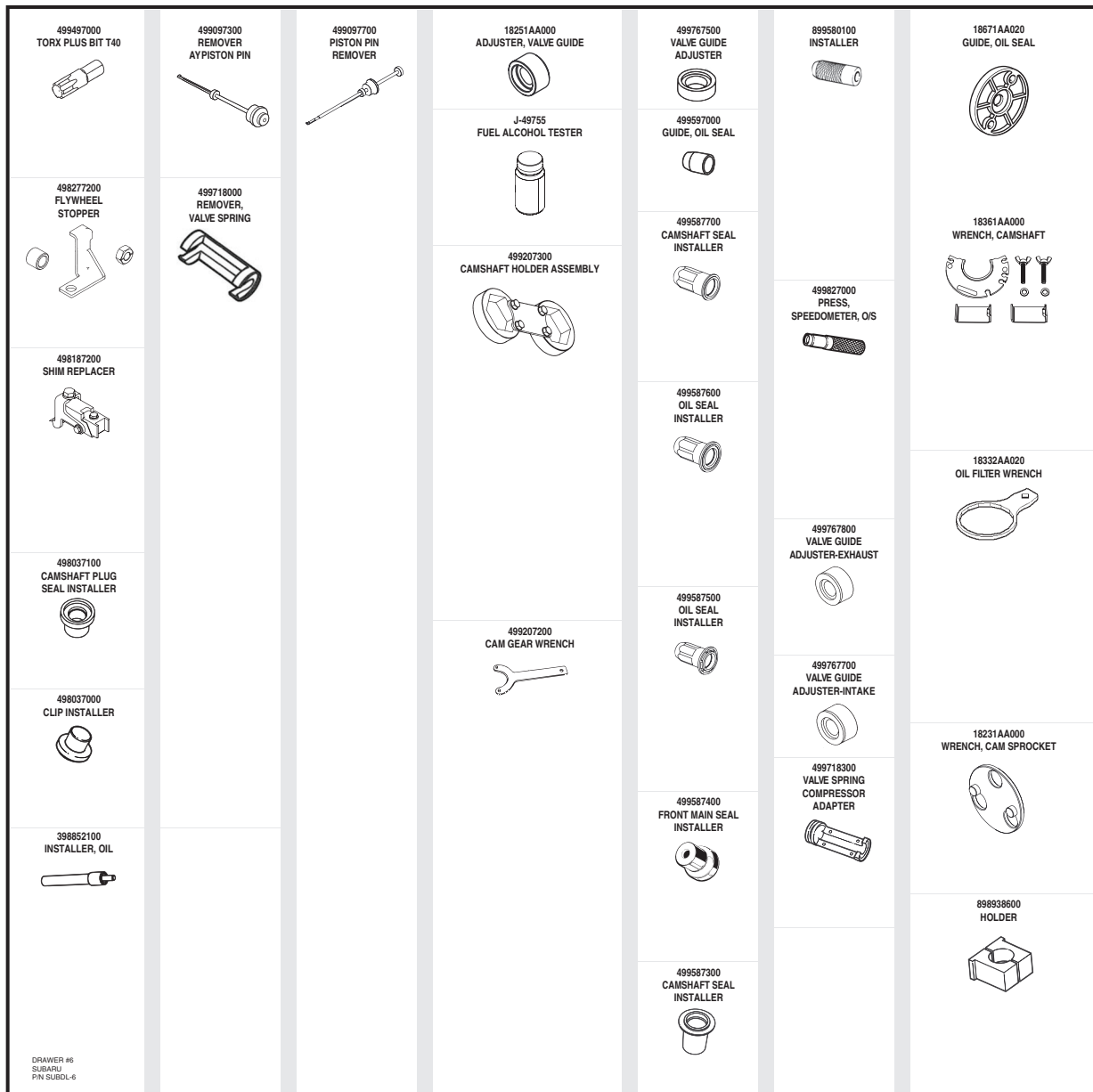

NOTE: GRAY HIGHLIGHTED TOOLS ARE NO LONGER ESSENTIAL.

Drawer Reference

DRAWER 7

- 18231AA020 WRENCH, CAM SHAFT SPROCKET
- 18233AA000 PLIERS, PISTON PIN
- 18251AA040 ADJUSTER, VALVE GUIDE
- 18251AA050 VALVE GUIDE ADJUSTER
- 18251AA060 VALVE GUIDE ADJUSTER
- 18252AA000 SOCKET, CRANKSHAFT
- 18253AA000 GUIDE, PISTON PIN
- 18258AA000 INSTALLER, ADJUSTER SPRING
- 18258AA001 INSTALLER, ADJUSTER SPRING
- 18261AA010 SEAL TOOL, VALVE GUIDE
- 18270AA020 SOCKET
- 18270AA040 SOCKET
- 18329AA000 REPLACER, SHIM
- 18334AA000 PIN SET
- 18334AA020 PIN SET, PULLEY WRENCH, INTAKE
- 18334AA030 PIN SET, PULLEY WRENCH, INTAKE
- 18334AA040 ADAPTERS, CAM PIN BOLT
- 18350AA000 REMOVER/INSTALLER, BUSHING
- 18354AA000 HOLDER, VALVE ROCKER
- 18355AA000 PULLEY WRENCH
- 18371AA000 RELEASE, QUICK-CONNECT
- 18471AA000 ADAPTER, FUEL PIPE
- 18657AA040 INSTALLER, OIL SEAL
- 41099AA020 ENGINE SUPPORT
- 41099AC000 ASSEMBLY, ENGINE SUPPORT
- 42099AE000 QUICK CONNECTOR, S/T
- 499585500 GUIDE, OIL SEAL
- 499765900 REAMER, VALVE GUIDE
- 499977500 HOLDING TOOL, CAMSHAFT SPROCKET
- 499987300 SOCKET WRENCH
- 899014100 PISTON PIN PRESS
- J-43979 VALVE SHIM POSITIONING TOOL
- J-50552 PIN SET, PULLEY WRENCH

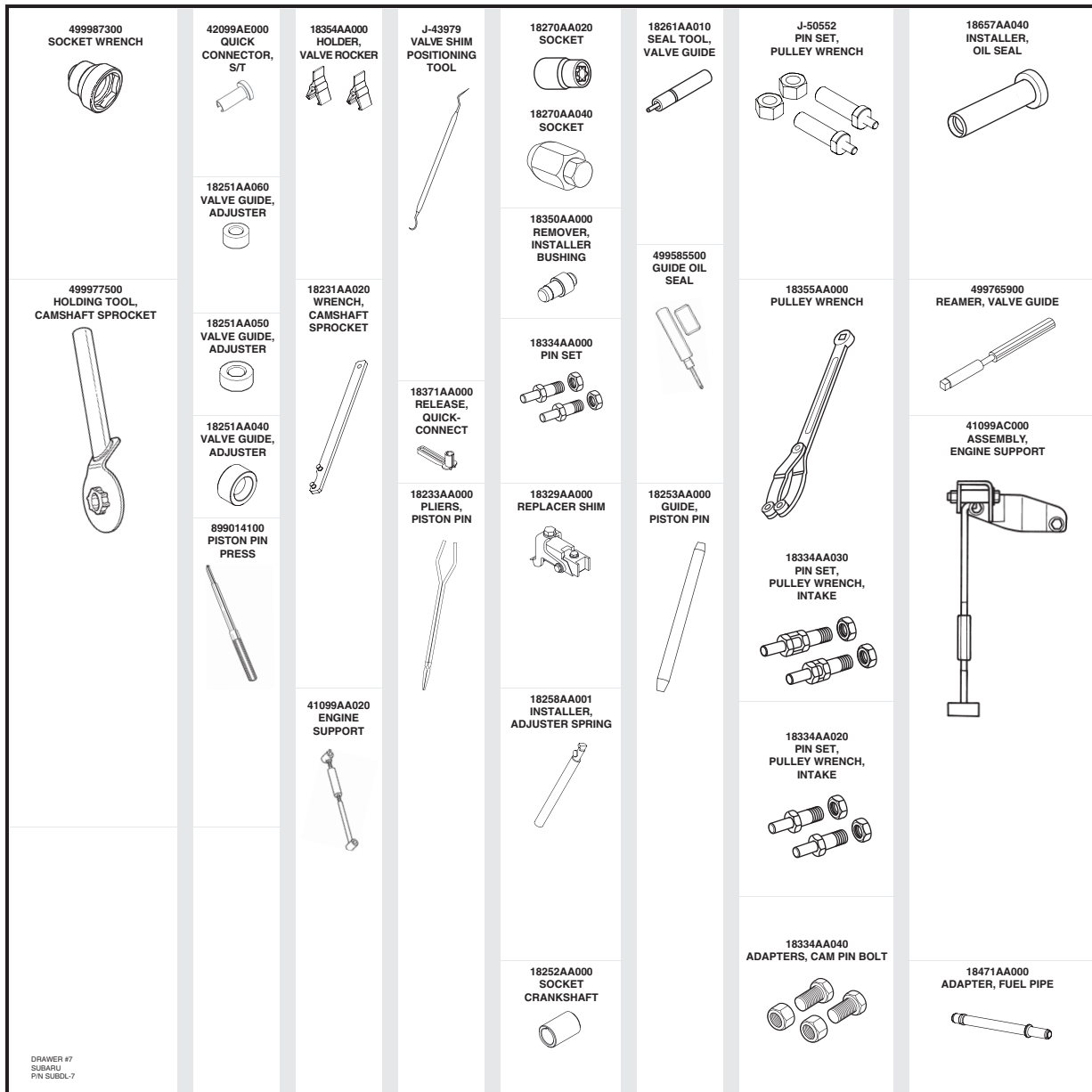









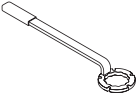



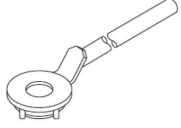

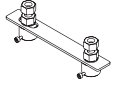

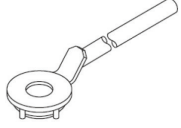

NOTE: GRAY HIGHLIGHTED TOOLS ARE NO LONGER ESSENTIAL.

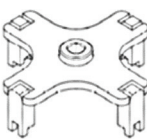
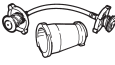
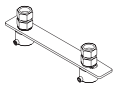
Drawer Reference

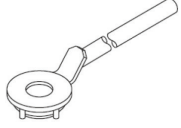
DRAWER 8

- | | |
|---|--|
| <input type="checkbox"/> 09260-39020-01 INJECTOR SEAL INSTALLER KIT | <input type="checkbox"/> 499990120 WRENCH |
| <input type="checkbox"/> 18271AA030 INJECTOR SEAL INSTALLER | <input type="checkbox"/> EN-49245-SUB INSTALLER/SIZER, INJECTOR SEAL |
| <input type="checkbox"/> 18271AA040 INJECTOR SEAL SIZER | <input type="checkbox"/> J-33984-A RADIATOR PRESSURE ADAPTS |
| <input type="checkbox"/> 18356AA000 REMOVER, DI INJECTOR | <input type="checkbox"/> J-41336 RADIATOR ADAPTER |
| <input type="checkbox"/> 18356AA001 REMOVER, DI INJECTOR | <input type="checkbox"/> J-42908 CAM SPROCKET HOLDER/UNLOADER |
| <input type="checkbox"/> 18356AA010 INJECTOR REMOVER | <input type="checkbox"/> J-44903 ADAPTER, FUEL CAP TEST |
| <input type="checkbox"/> 18360AA020 BRACKET, HANGAR H-6 | <input type="checkbox"/> J-45443 CAM SPROCKET HOLDER |
| <input type="checkbox"/> 18362AA060 LH #2 INJECTOR SPACER | |
| <input type="checkbox"/> 18362AA070 RH #1 INJECTOR SPACER | |
| <input type="checkbox"/> 18632AA020 STAND ASSEMBLY, TRANSMISSION | |
| <input type="checkbox"/> 18632AA030 ENGINE POSITIONER | |
| <input type="checkbox"/> 41099AJ000-A BRACKET, ENGINE SUPPORT H-6 | |
| <input type="checkbox"/> 41099AJ010-A BRACKET, ENGINE SUPPORT H-6 | |
| <input type="checkbox"/> 41099AJ130 BRACKET, ENGINE POSITIONING | |
| <input type="checkbox"/> 42099CA000 WRENCH, FUEL TANK RING | |
| <input type="checkbox"/> 42099FL000 FUEL PUMP RING TOOL | |
| <input type="checkbox"/> 499207400-A CAMSHAFT SPROCKET WRENCH | |
| <input type="checkbox"/> 499585700 OIL SEAL GUIDE | |
| <input type="checkbox"/> 499977100 CRANK PULLEY WRENCH | |
| <input type="checkbox"/> 499977400 CRANK PULLEY WRENCH | |

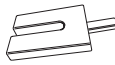
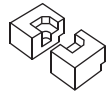
<p>499207400-A CAMSHAFT SPROCKET WRENCH</p> 	<p>09260-39020-01 INJECTOR SEAL INSTALLER KIT</p> 	<p>499585700 OIL SEAL GUIDE</p> 	<p>TOOLS LISTED BELOW MOVED TO PAGE 34 "OVERHEAD TOOLS: J-50135-B ENGINE SUPPORT KIT" AS OF APRIL 2021</p> <ul style="list-style-type: none"> • 90119 14120 - BOLT, ENGINE BRACKET • 18360AA040 - ENGINE HANGER • 12281-38150 - BRACKET, ENGINE HANGER 	<p>42099CA000 WRENCH, FUEL TANK RING</p> 
<p>499977400 CRANK PULLEY WRENCH</p> 	<p>499977100 CRANK PULLEY WRENCH</p> 	<p>J-45443 CAM SPROCKET HOLDER</p> 	<p>EN-49245-SUB INSTALLER/SIZER, INJECTOR SEAL</p> 	<p>41099AJ010-A BRACKET, ENGINE SUPPORT H-6</p> 
<p>499977400 CRANK PULLEY WRENCH</p> 	<p>499977100 CRANK PULLEY WRENCH</p> 	<p>J-44903 ADAPTER, FUEL CAP TEST</p> 	<p>18356AA001 REMOVER, INJECTOR</p> 	<p>41099AJ000-A BRACKET, ENGINE SUPPORT H-6</p> 
<p>42099FL000 FUEL PUMP RING TOOL</p> 	<p>J-41336 RADIATOR ADAPTER</p> 	<p>J-42908 CAM SPROCKET HOLDER/UNLOADER</p> 	<p>18356AA010 INJECTOR REMOVER</p> 	<p>41099AJ130 BRACKET, ENGINE POSITIONING</p> 
<p>499977400 CRANK PULLEY WRENCH</p> 	<p>J-33984-A RADIATOR PRESSURE ADAPTS</p> 	<p>18271AA030 INJECTOR SEAL INSTALLER</p> 	<p>18271AA040 INJECTOR SEAL INSTALLER</p> 	<p>18360AA020 BRACKET, HANGER H-6</p> 
<p>DRAWER #8 SUBARU PN SUBDL-8</p>			<p>18632AA030 ENGINE POSITIONER</p> 	<p>18632AA020 STAND ASSEMBLY, TRANSMISSION</p> 

NOTE: GRAY HIGHLIGHTED TOOLS ARE NO LONGER ESSENTIAL.

Drawer Reference

DRAWER 9

- 24036AA010 JUMPER WIRE SET
- 98299AG000 TEST HARNESS
- 98299AG070 TEST HARNESS AG
- 98299FC041 HARNESS, I2 TEST AIR BAG
- 98299FE030 HARNESS, TEST (R)
- 98299PA030 AIR BAG DEPLOYMENT HARNESS
- 98299SA020 HARNESS, TEST (P)
- SOA814001T RELAY PLIERS

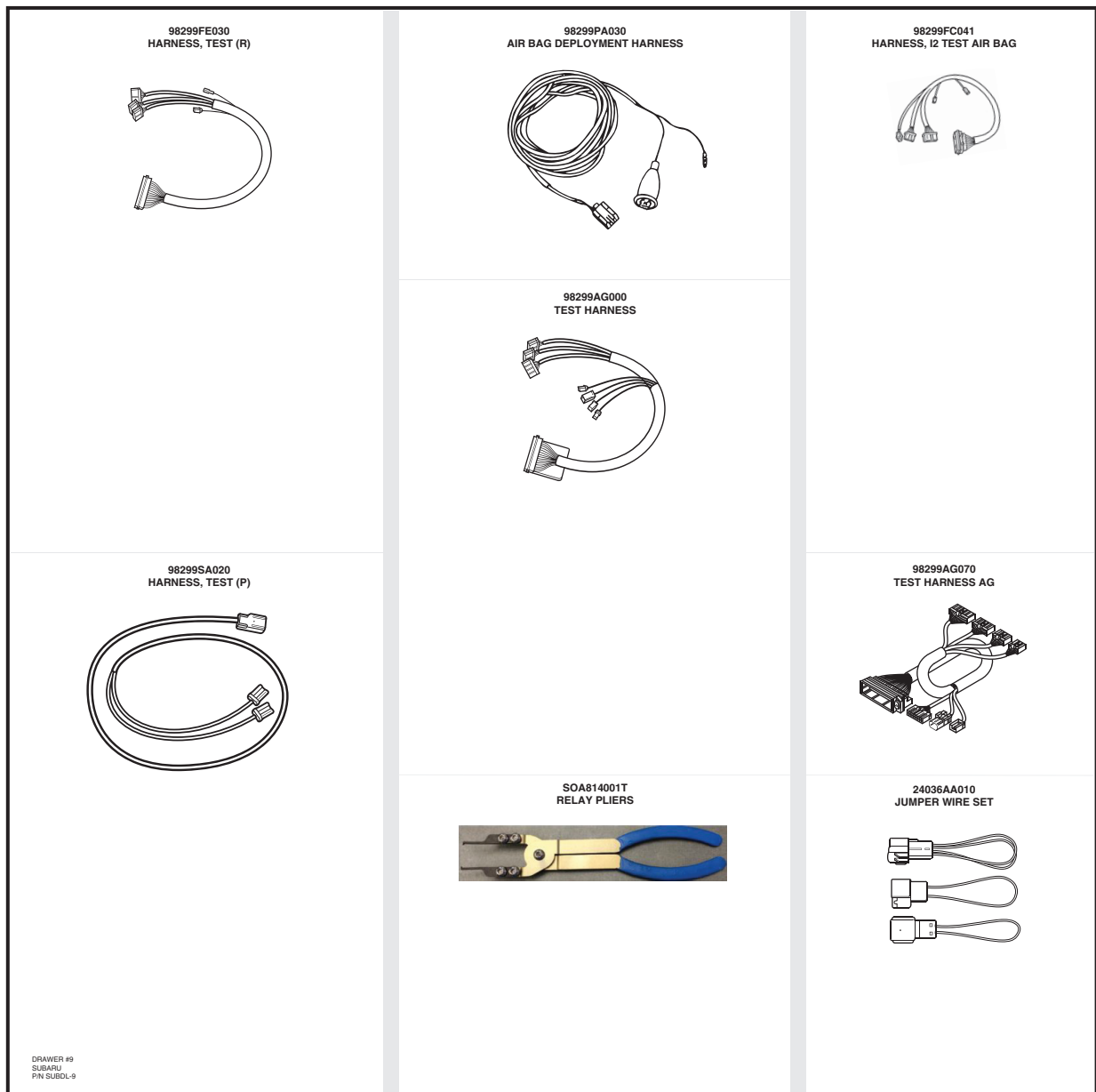









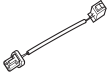

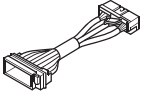

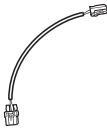
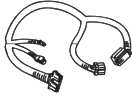
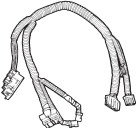
NOTE: GRAY HIGHLIGHTED TOOLS ARE NO LONGER ESSENTIAL.

Drawer Reference

DRAWER 10

- 98299AG080 TEST HARNESS, AIR BAG
- 98299CA000 TEST HARNESS AD/AR
- 98299CA010 TEST HARNESS
- 98299CA020 TEST HARNESS AD/AR/AT
- 98299FC030 A, ADAPTER
- 98299FG000 TEST HARNESS - AJ
- 98299PA000 AIR BAG TEST HARNESS A
- 98299PA011 AIR BAG HARNESS
- 98299PA020 AIR BAG TEST HARNESS C
- 98299PA040 AIR BAG RESISTOR
- 98299SA000 HARNESS, TEST (N)
- 98299SA010 HARNESS, TEST (D)
- 98299SA040 HARNESS, TEST (Q)
- 98299SA060 HARNESS, TEST
- J-39401-4 NUTS, 6MM RECESSE

<p>98299CA000 TEST HARNESS AD/AR</p> 	<p>98299PA020 AIRBAG TEST HARNESS - C</p> 	<p>98299AG080 TEST HARNESS, AIR BAG</p> 	<p>98299SA040 HARNESS, TEST (Q)</p> 	<p>98299CA010 TEST HARNESS</p> 
<p>98299FC030 A, ADAPTER</p> 	<p>98299PA000 AIRBAG TEST HARNESS - A</p> 	<p>98299PA011 AIRBAG HARNESS</p> 	<p>J-39401-4 NUTS, 6MM RECESSED</p> 	<p>98299CA020 TEST HARNESS AD/AR/AT</p> 
<p>98299FG000 TEST HARNESS - AJ</p> 	<p>98299SA010 HARNESS, TEST (D)</p> 	<p>98299SA060 HARNESS, TEST</p> 	<p>98299PA040 AIRBAG RESISTOR</p> 	<p>98299SA000 HARNESS, TEST (N)</p> 

NOTE: GRAY HIGHLIGHTED TOOLS ARE NO LONGER ESSENTIAL.

Drawer Reference

DRAWER 11

- 34199AG100 POWER STEERING TEST HARNESS
- 98299AG090 TEST HARNESS AI
- 98299FC000 SUBARU AIRBAG HARNESS
- 98299FC010 SUBARU AIRBAG HARNESS
- 98299FC020 SUBARU AIRBAG HARNESS
- 98299FC040 AIR BAG TEST HARNESS
- 98299FE000 HARNESS, TEST L
- 98299FE020 HARNESS, TEST M
- 98299FG010 TEST HARNESS AD-K
- 98299FJ030 TEST HARNESS, AIR BAG
- 98299FL010 TEST HARNESS BA
- 98299FL020 ODS HARNESS, TEST BB
- 98299FL030 ODS HARNESS, TEST BC (2 each)
- 98299SA030 HARNESS, TEST (E)

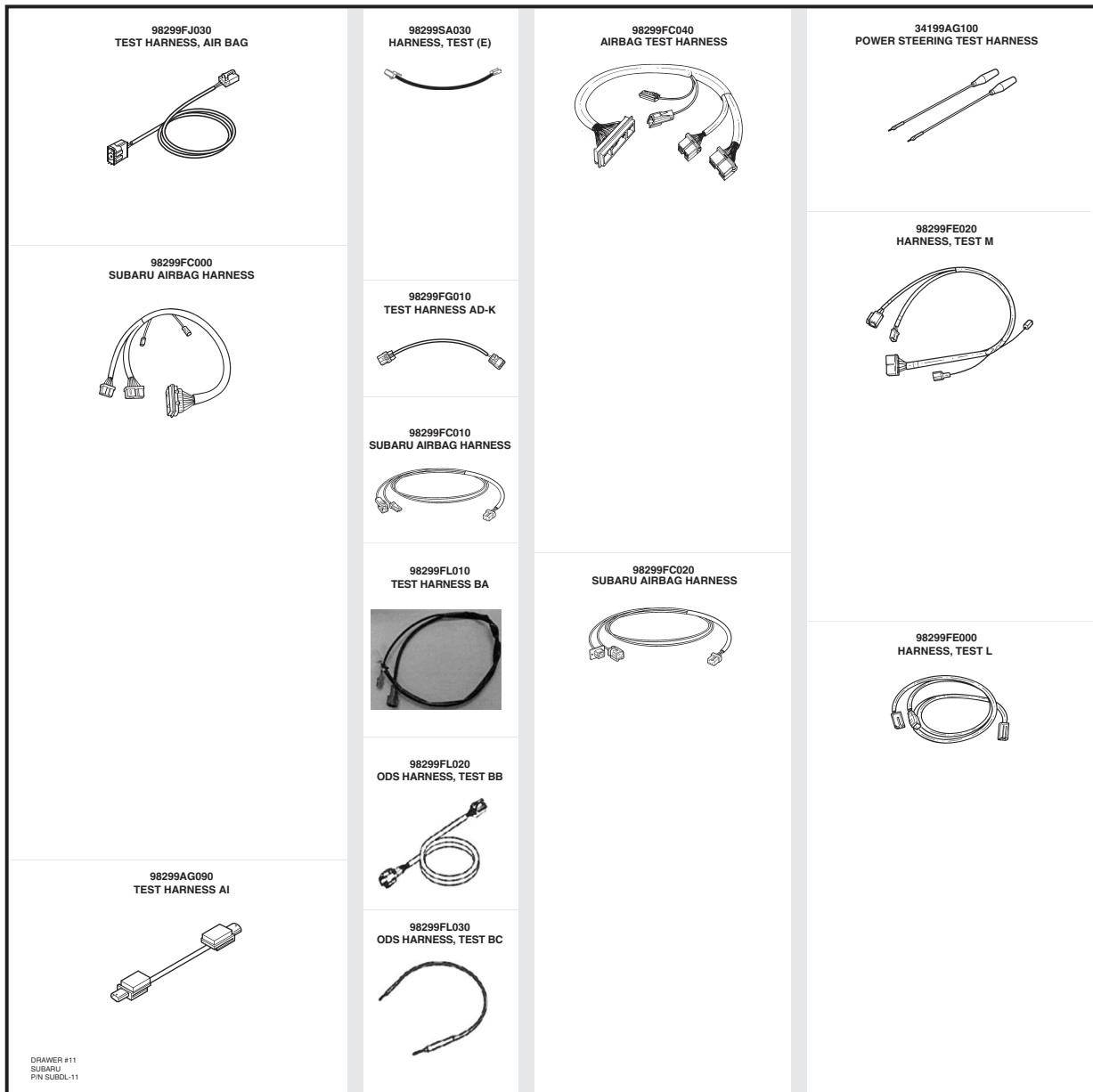

NOTE: GRAY HIGHLIGHTED TOOLS ARE NO LONGER ESSENTIAL.

Drawer Reference

DRAWER 12

- 98299AE000 HARNESS, TEST (K)
- 98299AG010 TEST HARNESS V
- 98299AG030 TEST HARNESS
- 98299AG040 TEST HARNESS Y
- 98299AG050 TEST HARNESS Z
- 98299AG060 TEST HARNESS D
- 98299AL000 TEST HARNESS
- 98299AL010 TEST HARNESS
- 98299AL020 TEST HARNESS
- 98299AL030 TEST HARNESS
- 98299AN010 TEST HARNESS BA, DOOR SENSOR DIAGNOSTICS
- 98299FA030-1 AIR BAG TEST HARNESS
- 99804AA000 CONNECTOR PIN TOOL WIRE HARNESS

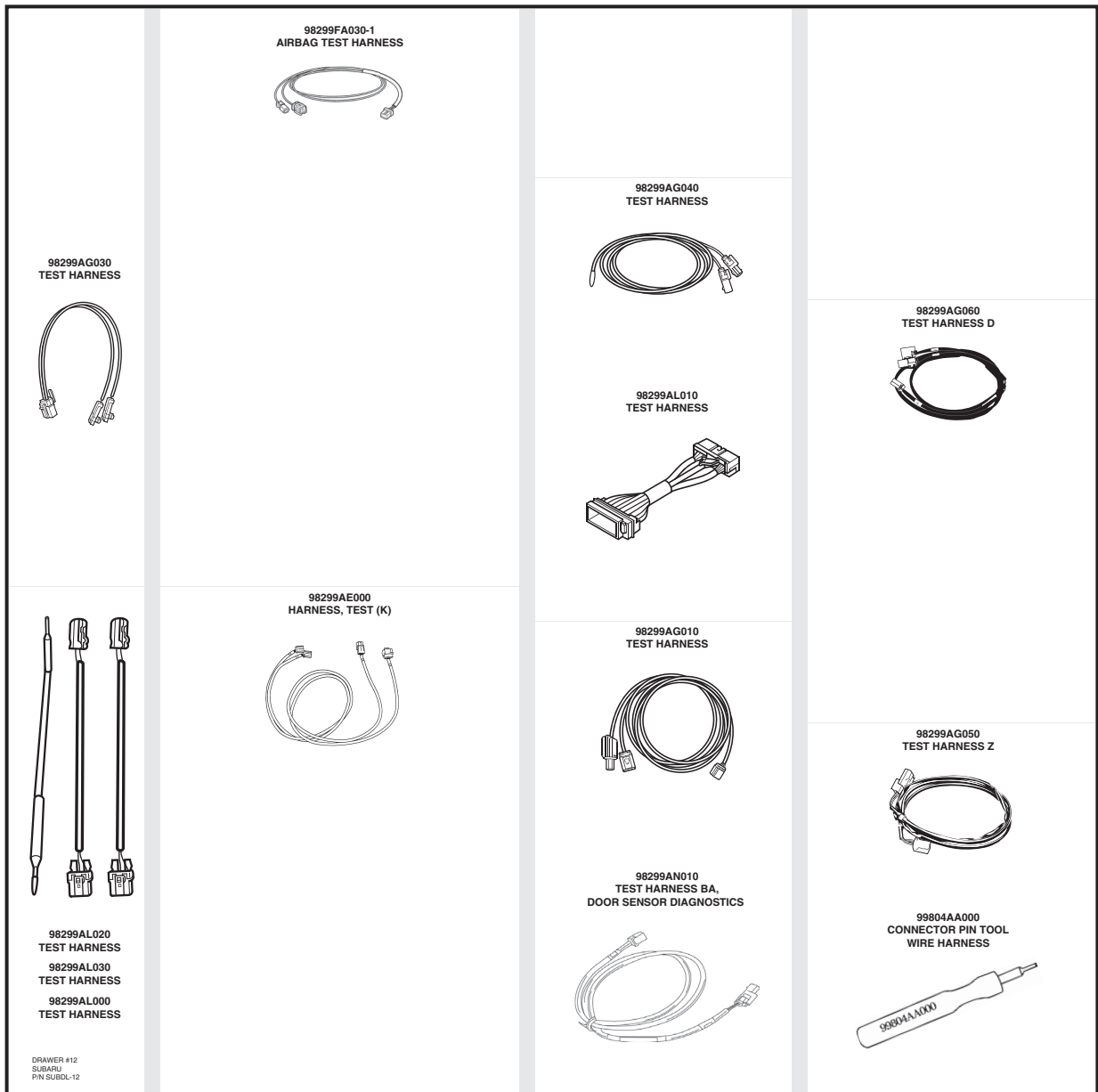

NOTE: GRAY HIGHLIGHTED TOOLS ARE NO LONGER ESSENTIAL.

Drawer Reference

DRAWER 13

- | | |
|--|---|
| <input type="checkbox"/> 18657AA010 INSTALLER,OIL SEAL | <input type="checkbox"/> 499577000 GAUGE TRANSFER |
| <input type="checkbox"/> 18663AA000 SOCKET,COVER OIL PUMP, T40 | <input type="checkbox"/> 499757002 INSTALLER |
| <input type="checkbox"/> 28499SG000 SPECIAL PLATE A (Part of J-53014 Kit) | <input type="checkbox"/> 499767000 ADJUSTER, VALVE GUIDE |
| <input type="checkbox"/> 28499SG010 SPECIAL PLATE SPACER B (Part of J-53014 Kit) | <input type="checkbox"/> 499787000 WRENCH ASSEMBLY |
| <input type="checkbox"/> 28499SG020 BOLT(S) (Part of J-53014 Kit) | <input type="checkbox"/> 499787100 WRENCH ASSEMBLY DRIVE PINION |
| <input type="checkbox"/> 398487700 DRIFT, GE CARRIER SIDE BEARING | <input type="checkbox"/> 499857000 REMOVER ASSEMBLY DRIVE GEAR |
| <input type="checkbox"/> 398497701 PILOT | <input type="checkbox"/> 499877000 INSTALLER, RACE 4-5 |
| <input type="checkbox"/> 398527700 O/SL & PULLER | <input type="checkbox"/> 899864100 INSTALLER |
| <input type="checkbox"/> 398643600 GAUGE | <input type="checkbox"/> J-53014 REAR HUB PULLER KIT |
| <input type="checkbox"/> 498077300 REMOVER | |
| <input type="checkbox"/> 498077400 SYNCHRONIZER CONE REMOVER | |
| <input type="checkbox"/> 498247100 DIAL GAUGE | |
| <input type="checkbox"/> 498255400 PLATE, MAGNET BASE | |
| <input type="checkbox"/> 498427000 STOPPER DRIVE PINION | |
| <input type="checkbox"/> 498427100 STOPPER, DRIVE PINION | |
| <input type="checkbox"/> 498515700 REMOVER | |
| <input type="checkbox"/> 498517000 REPLACER, DRIVE PINION | |
| <input type="checkbox"/> 498787100 STOPPER, MAIN SHAFT | |
| <input type="checkbox"/> 498937000 HOLDER, TRANSMISSION | |
| <input type="checkbox"/> 499277100 INSTALLER, BUSH 1-2 | |

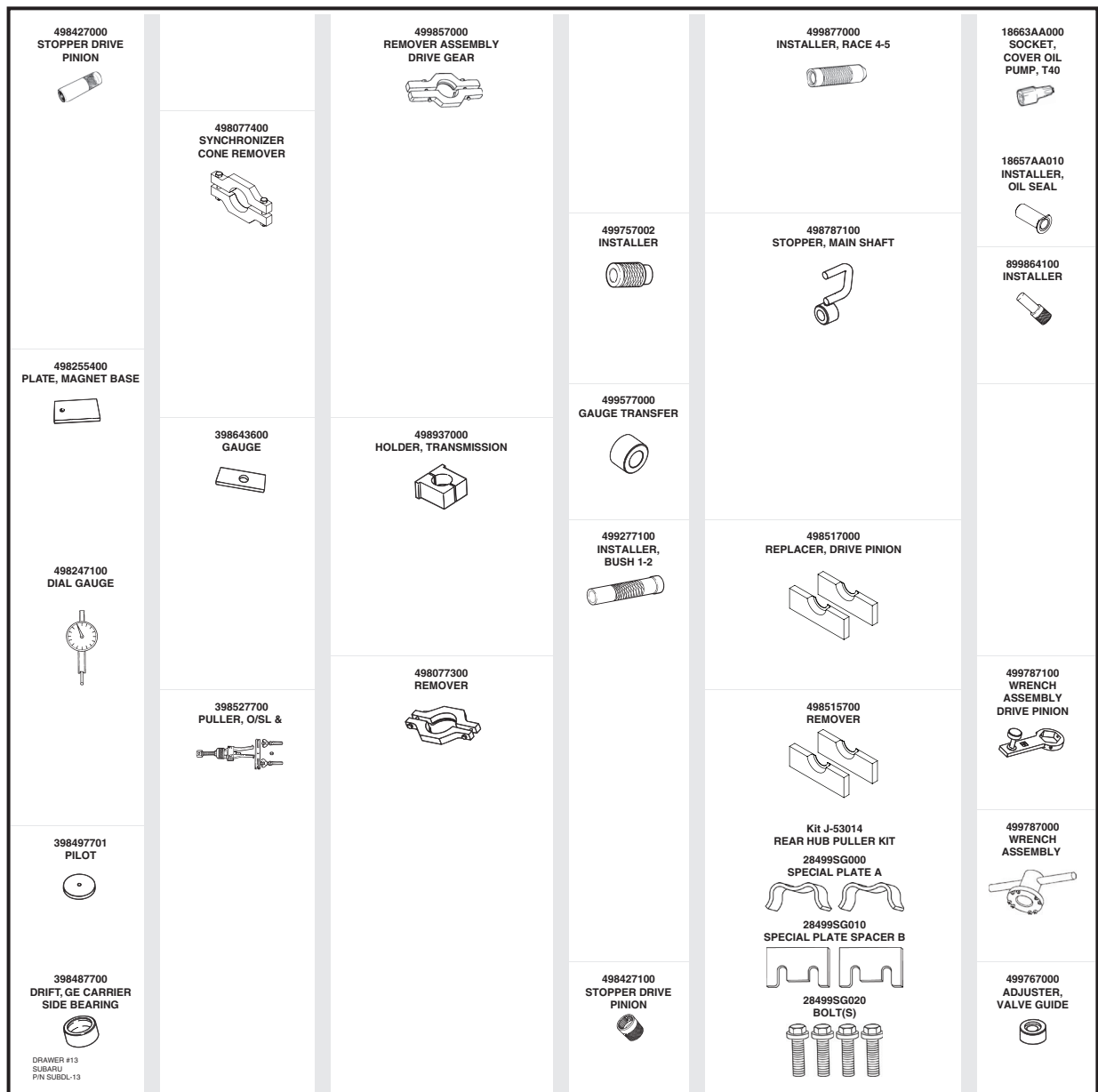

NOTE: GRAY HIGHLIGHTED TOOLS ARE NO LONGER ESSENTIAL.

Drawer Reference

DRAWER 14

- 18620AA000 ASSEMBLY, WRENCH
- 18621AA000 WRENCH ASSEMBLY, DRIVE PIN
- 18631AA000 HANDLE
- 18632AA000 SET(4), STAND PIN
- 18667AA020 HOLDER, DRIVE PINION
- 18672AA000 GUIDE, CLIP
- 18722AA000 REMOVER ASSEMBLY, 6TH
- 398177700 INSTALLER
- 498175500 DIFFERENTIAL TOOL
- 499917500 GAGE ASSEMBLY, DRIVE PINION
- 499927100 HANDLE, TRANSMISSION MAIN SHAFT
- 899858600 RETAINER
- 899884100 HOLDER

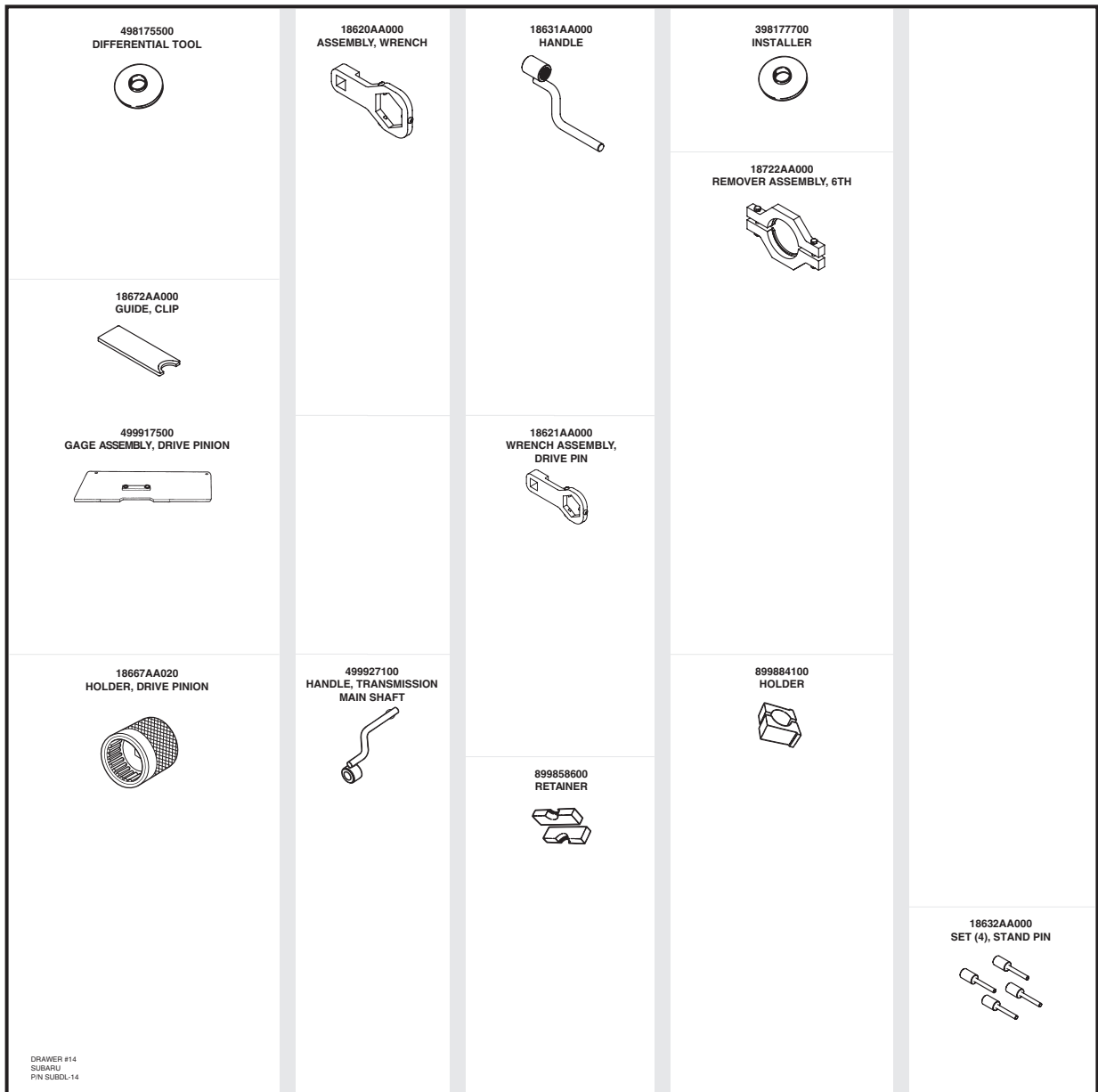

NOTE: GRAY HIGHLIGHTED TOOLS ARE NO LONGER ESSENTIAL.

Drawer Reference

DRAWER 15

- | | |
|---|---|
| <input type="checkbox"/> 18270KA010 TORX SOCKET E16 | <input type="checkbox"/> 498937110 SHAFT HOLDER |
| <input type="checkbox"/> 18362AA050 ADAPTER, CHAIN REMOVER | <input type="checkbox"/> J-53038 CASE COVER REMOVAL KIT |
| <input type="checkbox"/> 18363AA060 BOLT, CHAIN COVER REMOVER | <input type="checkbox"/> SOA625336 GAUGE PLATE |
| <input type="checkbox"/> 18651AA000 INSTALLER, MAIN SHAFT | |
| <input type="checkbox"/> 18657AA000 INSTALLER, SEAL | |
| <input type="checkbox"/> 18662AA010 SOCKET, HYPOID | |
| <input type="checkbox"/> 18668AA000 PUNCH, MAINSHAFT | |
| <input type="checkbox"/> 18669AA000 PUNCH, DRIVEN SHAFT | |
| <input type="checkbox"/> 18670AA000 PUNCH, DRIVE PIN | |
| <input type="checkbox"/> 18671AA000 GUIDE, OIL SEAL | |
| <input type="checkbox"/> 18680AA020 HOLDER, GEAR | |
| <input type="checkbox"/> 18720AA000 REMOVER ASSEMBLY, 3RD | |
| <input type="checkbox"/> 18723AA000 REMOVER ASSEMBLY, DRIVEN GEAR | |
| <input type="checkbox"/> 18754AA000 REMOVER, BUSHING | |
| <input type="checkbox"/> 18757AA000 REMOVER, STRAIGHT PIN | |
| <input type="checkbox"/> 18758AA000 PULLER | |
| <input type="checkbox"/> 18766AA000 SUPPORT, PULLER | |
| <input type="checkbox"/> 34299CA000 WRENCH, PINION NUT | |
| <input type="checkbox"/> 498937100 HOLDER, DRIVE PINION | |

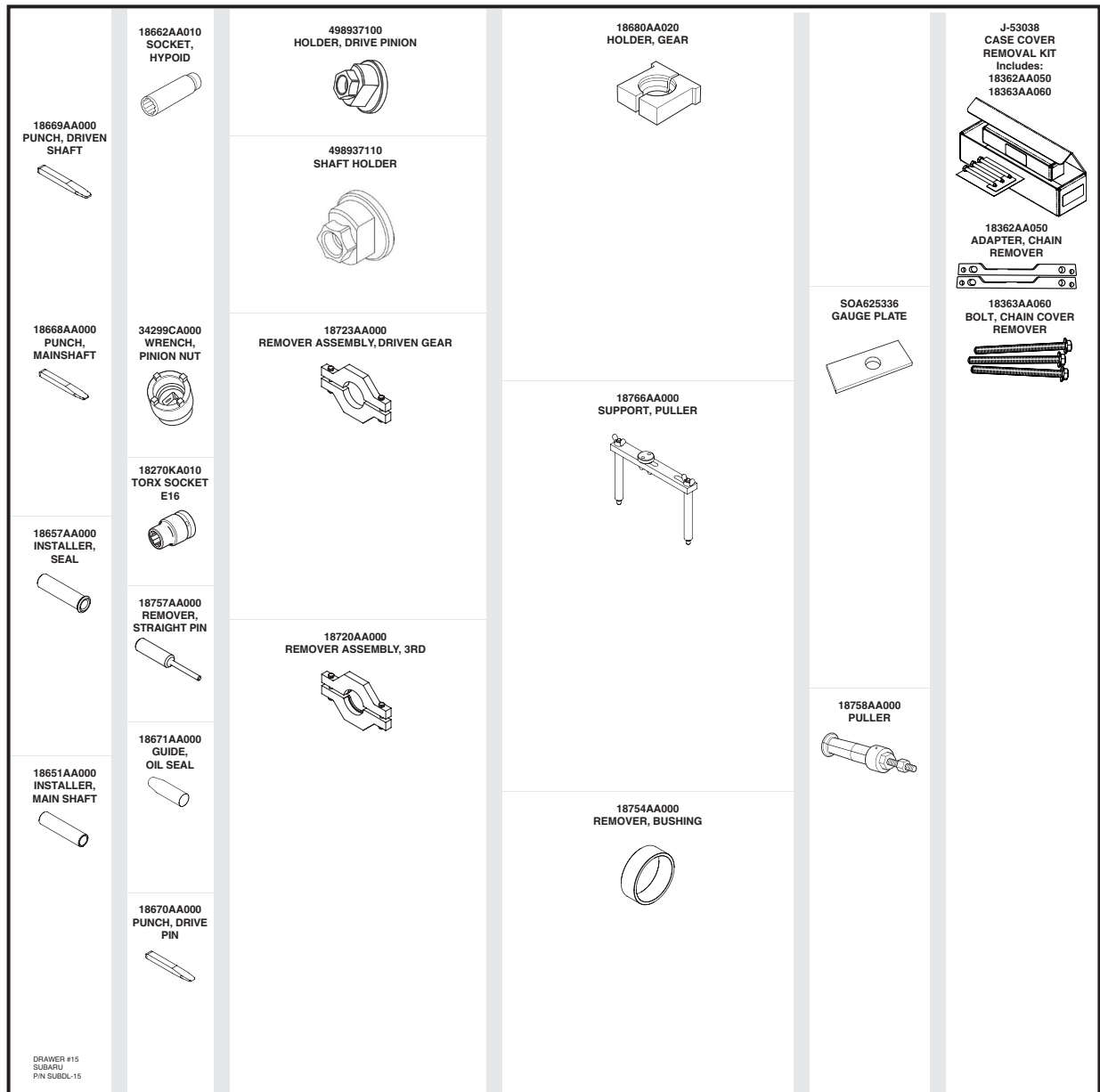

NOTE: GRAY HIGHLIGHTED TOOLS ARE NO LONGER ESSENTIAL.

Drawer Reference

DRAWER 16

- 18630AA000 RETAINER WRENCH
- 18664AA000 BASE
- 18665AA000 HOLDER
- 18666AA000 HOLDER
- 18667AA000 HOLDER
- 18831AA000 GAUGE
- 399780104 WEIGHT BACKLASH
- 499247300 INSTALLER DRIVE PINION
- 499787000 WRENCH ASSEMBLY

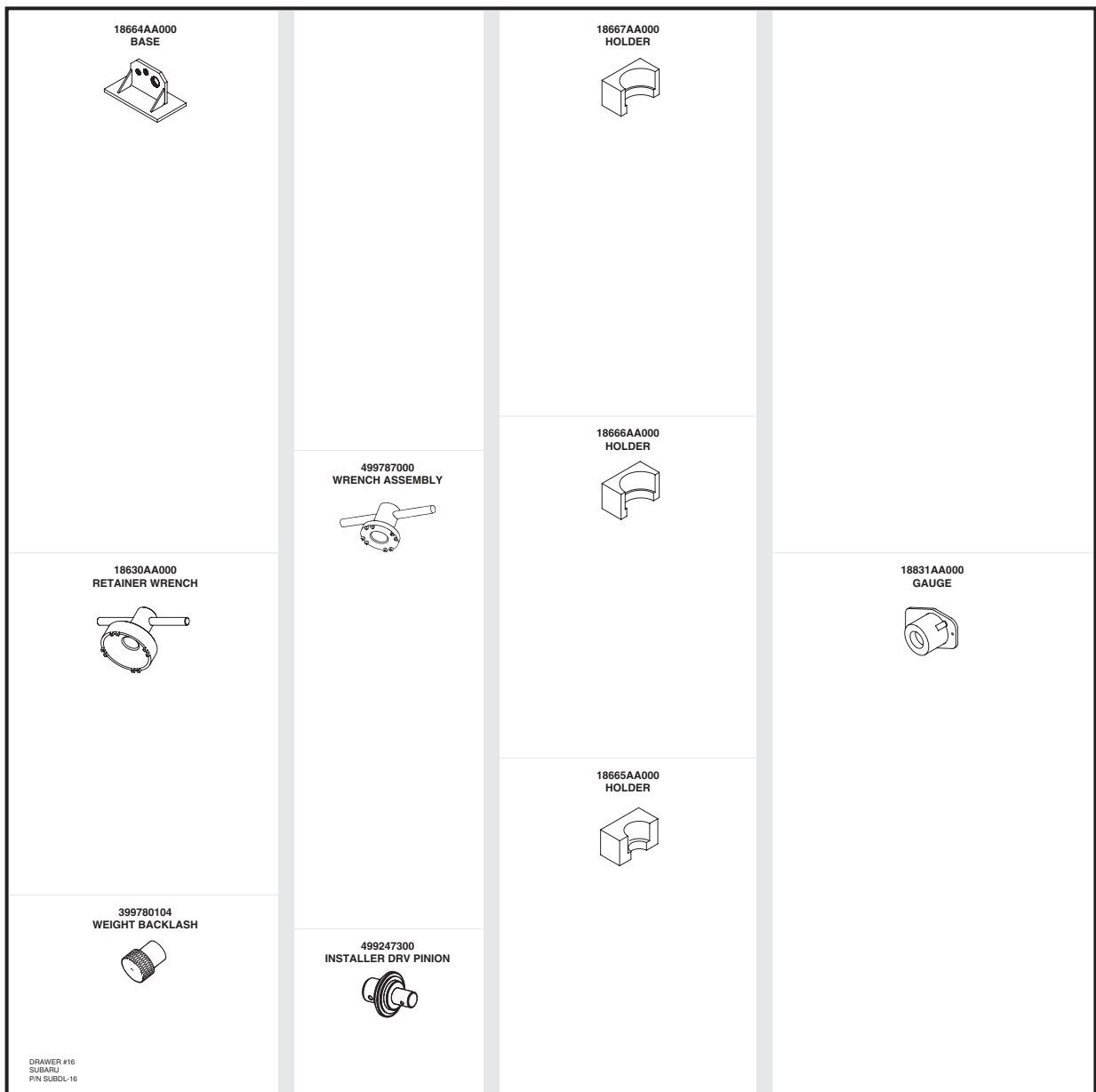











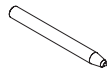













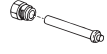

NOTE: GRAY HIGHLIGHTED TOOLS ARE NO LONGER ESSENTIAL.

Drawer Reference

DRAWER 17

- 34099FA030 INSTALLER
- 34099FA060 PUNCH
- 34099FA100 STEERING GEAR STAND BASE
- 34099FA110 RACK HOUSING SEAL INSTALLER
- 34099FA120 VALVE HOUSING BEARING SEAL TL
- 34099FA130 VALVE HOUSING SEAL INSTALLER
- 34099FA140 RACK HOUSING SEAL REMOVER
- 34099PA000 PISTON RING SEAL INSTALLER
- 34099PA030 INNER RACK SEAL INSTALLER
- 34099PA040 INNER RACK SEAL PROTECTOR
- 34099PA050 OIL SEAL INSTALLER
- 34099PA060 PINION BEARING RECEIVER
- 34099PA070 PINION BEARING REMOVER
- 34199AG060 GUIDE, POWER ASSISTED STEERING SEALING RING
- 34199FE040 INSTALLER
- 34199XA010 GUIDE
- 34199XA030 INSTALLER
- 34199XA060 SEAL REMOVER
- 926040000 SOCKET O2 SENSOR
- 926230000 SPANNER
- 926250000 GUIDE (P/S)
- 926340001 WRENCH
- 926390001 COVER ASSEMBLY
- 926420000 PLUG
- 927490000 INSTALLER
- 927650000 INSTALLER
- 927660000 GUIDE
- 927680000 INSTALLER & REMOVER

<p>927490000 INSTALLER</p> 	<p>34199XA060 SEAL REMOVER</p> 	<p>34199AG060 GUIDE, POWER ASSISTED STEERING SEALING RING</p> 	<p>34099FA060 PUNCH</p> 	<p>34099FA130 VALVE HOUSING SEAL INSTALLER</p> 	<p>34099PA060 PINION BEARING RECEIVER</p> 	<p>34099PA070 PINION BEARING REMOVER</p> 	<p>34099FA140 RACK HOUSING SEAL REMOVER</p> 
<p>926250000 GUIDE (P/S)</p> 		<p>34199XA030 INSTALLER</p> 		<p>34099FA030 INSTALLER</p> 	<p>34099FA110 RACK HOUSING SEAL INSTALLER</p> 	<p>34099PA050 OIL SEAL INSTALLER</p> 	
<p>926230000 SPANNER</p> 		<p>34199XA010 GUIDE</p> 	<p>927660000 GUIDE</p> 				
		<p>34099FA100 STEERING GEAR STAND BASE</p> 	<p>926420000 PLUG</p> 	<p>926390001 COVER ASSEMBLY</p> 		<p>34099PA040 INNER RACK SEAL PROTECTOR</p> 	
		<p>927680000 INSTALLER & REMOVER</p> 	<p>926340001 WRENCH</p> 		<p>927650000 INSTALLER</p> 	<p>34099PA030 INNER RACK SEAL PROTECTOR</p> 	
<p>34199FE040 INSTALLER</p> 		<p>926040000 SOCKET O2 SENSOR</p> 				<p>34099PA000 PISTON RING SEAL INSTALLER</p> 	
						<p>34099FA120 VALVE HOUSING BEARING SEAL TOOL</p> 	

NOTE: GRAY HIGHLIGHTED TOOLS ARE NO LONGER ESSENTIAL.

Drawer Reference

DRAWER 18

- 34099AC010 ADAPTER HOSE A
- 34099AC020 ADAPTER HOSE B
- 34099PA010 INNER RACK SEAL REMOVER
- 34099PA100 PINION LOCKNUT WRENCH
- 34199AE030 SEAL INSTALLER
- 34199AE050 REMOVER
- 34199AG000 BOSS D
- 34199AG010 INSTALLER
- 34199AG020 GUIDE
- 34199AG030 GUIDE
- 34199AG050 GUIDE
- 34199AG070 FORMER
- 34199AG080 FORMER
- 34199AG090 INSTALLER
- 34199AJ030 BACKLASH LOCKING WRENCH
- 34199AJ040 BACKLASH HOLDING WRENCH
- 34199AJ060 PINION NUT WRENCH
- 34199FE000 INSTALLER AND REMOVER
- 34199XA000 INSTALLER
- 34199XA020 FORMER
- 0961600020 SOCKET, STEERING PRELOAD
- 927580000 REMOVER
- 98299XA000 HARNESS, AB TEST

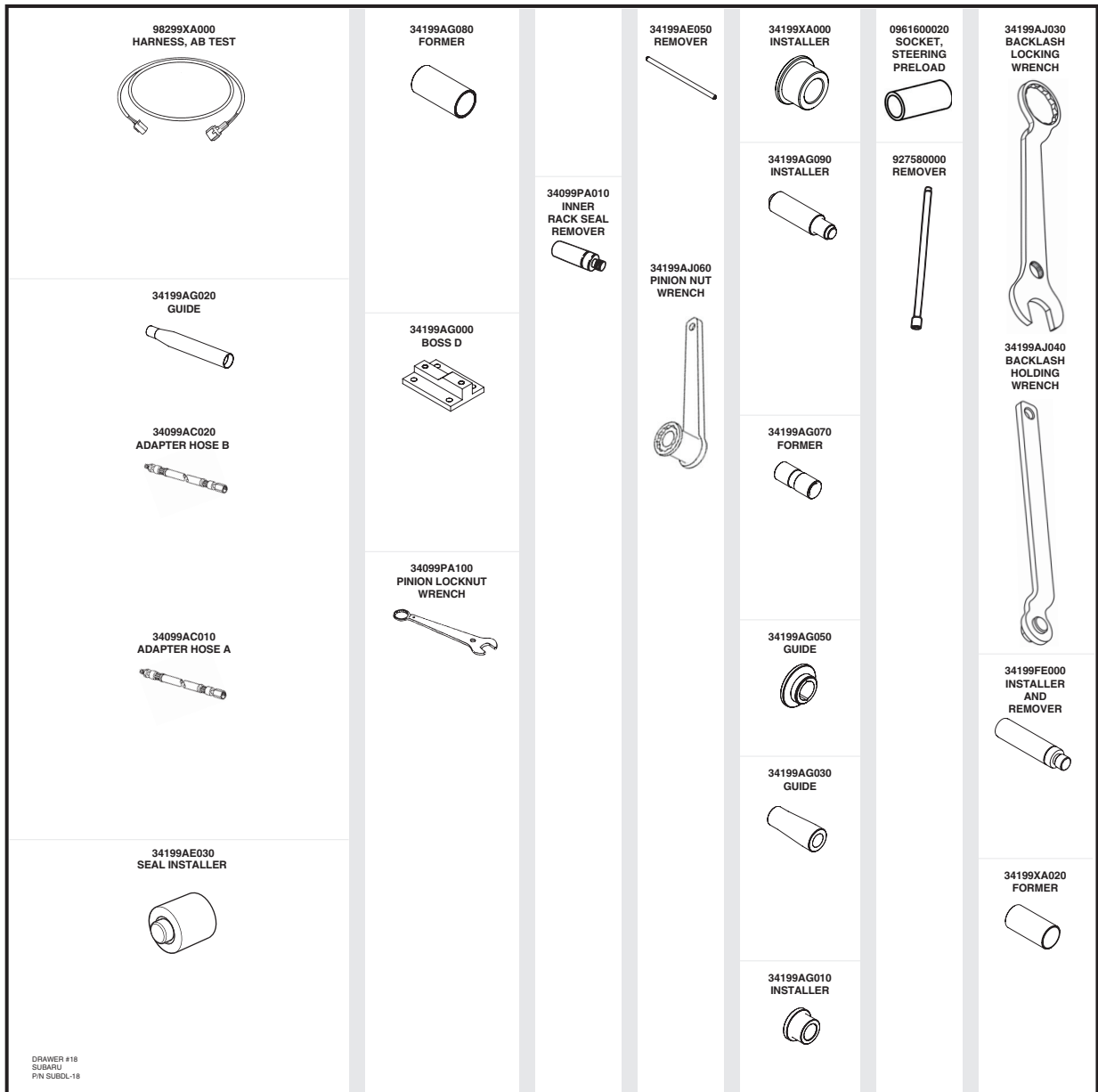

NOTE: GRAY HIGHLIGHTED TOOLS ARE NO LONGER ESSENTIAL.

Drawer Reference

DRAWER 19

- 925711000-A POWER STEERING PRESSURE TESTER
- 926200000 STAND, GEAR BOX
- 98299XA010 HARNESS, AC TEST
- 98299XA020 HARNESS, AD TEST
- 98299XA030 HARNESS, AE TEST

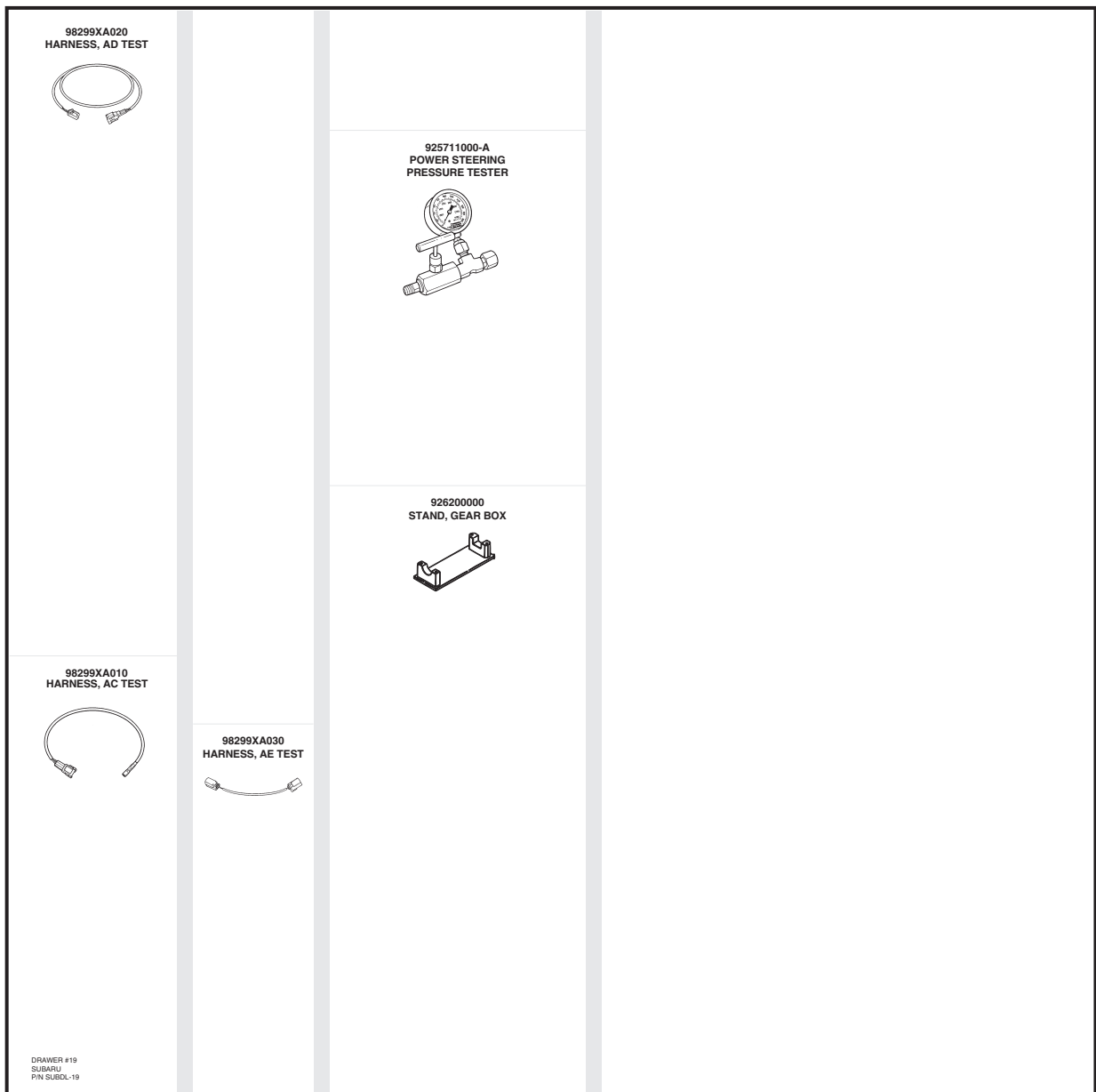

















NOTE: GRAY HIGHLIGHTED TOOLS ARE NO LONGER ESSENTIAL.

Drawer Reference

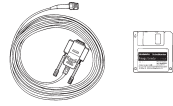
DRAWER 20

- 18283AA000 WRENCH
- 18283AA010 ADAPTER, EPF REMOVAL TOOL
- 18482AA010RA CARTRIDGE, SMII 2001-2006
- 22775AA050 PC CABLE W/PRINTER SOFTWARE
- 22783AA001 SELECT MONITOR II RETRO CABLE
- 22784AA000 PRINTOUT SOFTWARE
- 24082AA080 CARTRIDGE, SSMII/NSM 1996-1997
- 24082AA130RA CARTRIDGE, SSMII/NSM 1998-2000
- 24082AA290 CARTRIDGE, SSMII/NSM IMMOBILIZER 2005
- 61299CA000 DOOR ALIGNER REGULATOR
- 61299CA010 DOOR ALIGNER REGULATOR
- 73099SG000 CONDENSER, SPECIAL WRENCH
- 73499XA00A REMOVER, HIGH PRESSURE A/C
- 73499XA01A REMOVER, LOW PRESSURE A/C
- 926480000 PLATE AXLE SHAFT PULLER
- SOA629389 DRIVE PINION INSTALLER
- SOA638654 CONNECTOR REMOVERS









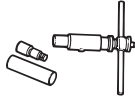

	<p>61299CA000 DOOR ALIGNER, REGULATOR</p> 	<p>73099SG000 CONDENSER, SPECIAL WRENCH</p> 	<p>18283AA000 WRENCH</p> 
<p>18482AA010RA CARTRIDGE, SMII 2001-2006</p> 			<p>22784AA000 PRINTOUT SOFTWARE</p> 
<p>SOA638654 CONNECTOR REMOVERS</p> 	<p>61299CA010 DOOR ALIGNER, REGULATOR</p> 		<p>22783AA001 SELECT MONITOR II RETRO CABLE</p> 
<p>SOA629389 DRIVE PINION INSTALLER</p> 	<p>18283AA010 ADAPTER, EPF REMOVAL TOOL</p> 	<p>24082AA290 CART RIDGE, SSMII/NSM IMMOBILIZER 2005</p> 	
	<p>926480000 PLATE AXLE SHAFT PULLER</p> 	<p>24082AA130RA CARTRIDGE, SSMII/NSM 1998-2000</p> 	<p>22775AA050 PC CABLE W/PRINTER SOFTWARE</p> 
<p>73499XA01A REMOVER, LOW PRESSURE A/C</p> 		<p>24082AA080 CARTRIDGE, SSMII/NSM 1996-1997</p> 	
<p>73499XA00A REMOVER, HIGH PRESSURE A/C</p>  <p>DRAWER #20 SUBARU PIN SUBDL-20</p>			

NOTE: GRAY HIGHLIGHTED TOOLS ARE NO LONGER ESSENTIAL.

Drawer Reference

DRAWER 21

- 20099PA000 STRUT LOCK NUT WRENCH
- 20099PA010 BUSHING REPLACER
- 20299AG000 REMOVER, CONTROL ARM BUSHING
- 20299AG010 BASE, CONTROL ARM BUSHING
- 20399FG000 SOCKET 14
- 922431000 HOUSING INSTALLER
- 925091000 and 925091000-A BAND TIGHTNER, AXLE BOOT (Supersedes to OTC 4623)
- 927720000 INSTALLER & REMOVER
- 927760000 SOCKET, STRUT MOUNT
- 927820000 BASE TUBE















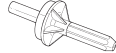

<p style="text-align: center;">922431000 HOUSING INSTALLER</p> 	<p style="text-align: center;">20399FG000 SOCKET 14</p> 	<p style="text-align: center;">20299AG000 REMOVER, CONTROL ARM BUSHING</p> 
	<p style="text-align: center;">20099PA000 STRUT LOCK NUT WRENCH</p> 	<p style="text-align: center;">20299AG010 BASE, CONTROL ARM BUSHING</p> 
	<p style="text-align: center;">927820000 BASE TUBE</p> 	
	<p style="text-align: center;">927760000 SOCKET, STRUT MOUNT</p> 	
	<p style="text-align: center;">925091000 and 925091000-A (Supersedes to OTC 4623) BAND TIGHTNER, AXLE BOLT</p> 	<p style="text-align: center;">20099PA010 BUSHING REPLACER</p> 
		<p style="text-align: center;">927720000 INSTALLER & REMOVER</p> 

NOTE: GRAY HIGHLIGHTED TOOLS ARE NO LONGER ESSENTIAL.

Drawer Reference

DRAWER 22

- 18675AA000 DIFFERENTIAL SIDE OIL SEAL INSTALLER
- 18682AA000 INSTALLER, HUB SEAL
- 28099AC000 AXLE BOOT CLAMP PLIERS
- 28099PA060 REAR HUB SUPPORT
- 28099PA070 HUB SEAL INSTALLERS
- 28099PA100 DRIVESHAFT REMOVER
- 28399SA000 DRIVE SHAFT REMOVER
- 28399SA010 PROTECTOR, AXLE SHAFT
- 41399FG001 REAR SUBFRAME BUSHING TOOL
- 927080000 PULLER, HUB
- 927100000 PULLER, BEARING
- 927430000 STAND, R HOUSING
- 927440000 PULLER, REAR WHEEL BEARING
- 927450000 INSTALLER, REAR HUB
- 927460000 INSTALLER, OIL SEAL
- 927640000 INSTALLER, B
- 99099AL000 BRAKE SEAL TOOL







<p>927450000 INSTALLER, REAR HUB</p> 	<p>28099PA060 REAR HUB SUPPORT</p> 	<p>28099PA100 DRIVE SHAFT REMOVER</p> 	<p>18682AA000 INSTALLER, HUB SEAL</p> 	<p>99099AL000 BRAKE SEAL TOOL</p> 	<p>41399FG001 REAR SUBFRAME BUSHING TOOL</p> 
<p>927440000 PULLER, REAR WHEEL BEARING</p> 			<p>28399SA000 DRIVE SHAFT REMOVER</p> 		<p>28099PA070 HUB SEAL INSTALLERS</p> 
	<p>18675AA000 DIFFERENTIAL SIDE OIL SEAL INSTALLER</p> 				<p>927430000 STAND, R HOUSING</p> 
<p>927100000 PULLER, BEARING</p> 	<p>927640000 INSTALLER, B</p> 	<p>28099AC000 AXLE BOOT CLAMP PLIERS</p> 		<p>28399SA010 PROTECTOR, AXLE SHAFT</p> 	<p>927080000 PULLER, HUB</p> 

NOTE: GRAY HIGHLIGHTED TOOLS ARE NO LONGER ESSENTIAL.

Drawer Reference

DRAWER 23

- 18460AA030 HARNESS DI TEST
- 18460AA040 CVT CHECK HARNESS
- 18657AA030 INSTALLER, OIL SEAL
- 18658AA020 FRONT DIFFERENTIAL RETAINING WRENCH
- 18801AA000 OIL PRESSURE GAUGE, CVT
- 41399CA000 BUSHING, R&R RH
- 41399CA050 BUSHING, R&R LH
- 99099FL000 TORSION BAR TOOL
- J-49863-1 FUEL CONNECTION TOOL

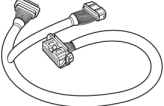
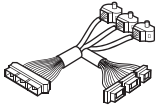
<p>41399CA000 BUSHING R&R RH</p> 	<p>41399CA050 BUSHING R&R LH</p> 	<p>J-49863-1 FUEL CONNECTION TOOL</p> 
<p>18657AA030 INSTALLER, OIL SEAL</p> 	<p>99099FL000 TORSION BAR TOOL</p> 	<p>18801AA000 OIL PRESSURE GAUGE, CVT</p> 
<p>18658AA020 FRONT DIFFERENTIAL RETAINING WRENCH</p> 	<p>18460AA120 CHECKBOARD HARNESS MOVED TO OVERHEAD 4/19</p>	<p>18460AA040 CVT CHECK HARNESS</p> 
<p>J-50972 TRUNK TORSION BAR MOVED TO OVERHEAD 4/19</p>	<p>18460AA050 CVT CHECKBOARD HARNESS MOVED TO OVERHEAD 4/19</p>	<p>18460AA030 HARNESS, DI TEST</p> 

DRAWER #23
SUBARU
PIN SUBDL-23

NOTE: GRAY HIGHLIGHTED TOOLS ARE NO LONGER ESSENTIAL.

Drawer Reference

DRAWER 24

- 09350-07110-SUB OIL SEAL REPLACER
- 09506-42020-SUB TRANSFER BEARING RACE REPLACER
- 09520-01011-SUB DRIVE ATTACHMENT
- 09521-02010-SUB ROD NO. 1
- 09521-02040-SUB WEIGHT NO. 1
- 09521-02060-SUB GRIP
- 09521-02070-SUB NUT NO. 1
- 09616-00011-SUB STEERING WORM BEARING ADJUSTING SOCKET
- 09617-24011-SUB STEERING RACK WRENCH
- 09812-00010-SUB DOOR HINGE SET BOLT WRENCH (12MM)
- 09830-01010-SUB BOLT
- 09830-01020-SUB NUT
- 09830-01040-SUB WASHER
- 09830-01050-SUB SPACER NO. 1
- 09830-01060-SUB SPACER NO. 2
- 09893-00020-SUB BATTERY GUIDE PIN
- 09893-72020-SUB RUBBER PAD SET
- 09951-00720-SUB REPLACER 72
- 09951-00890-SUB REPLACER 89
- 09951-04010-SUB HANGER 150
- 09952-04010-SUB SLIDE ARM
- 09954-04010-SUB ARM 25
- 09955-04061-SUB CLAW NO. 6
- 09958-04011-SUB HOLDER
- 81911-FL030-SUB CONNECTOR HOLDER
- 81911-FL040-SUB CONNECTOR HOLDER
- 99804-AN030-SUB REPAIR TOOL

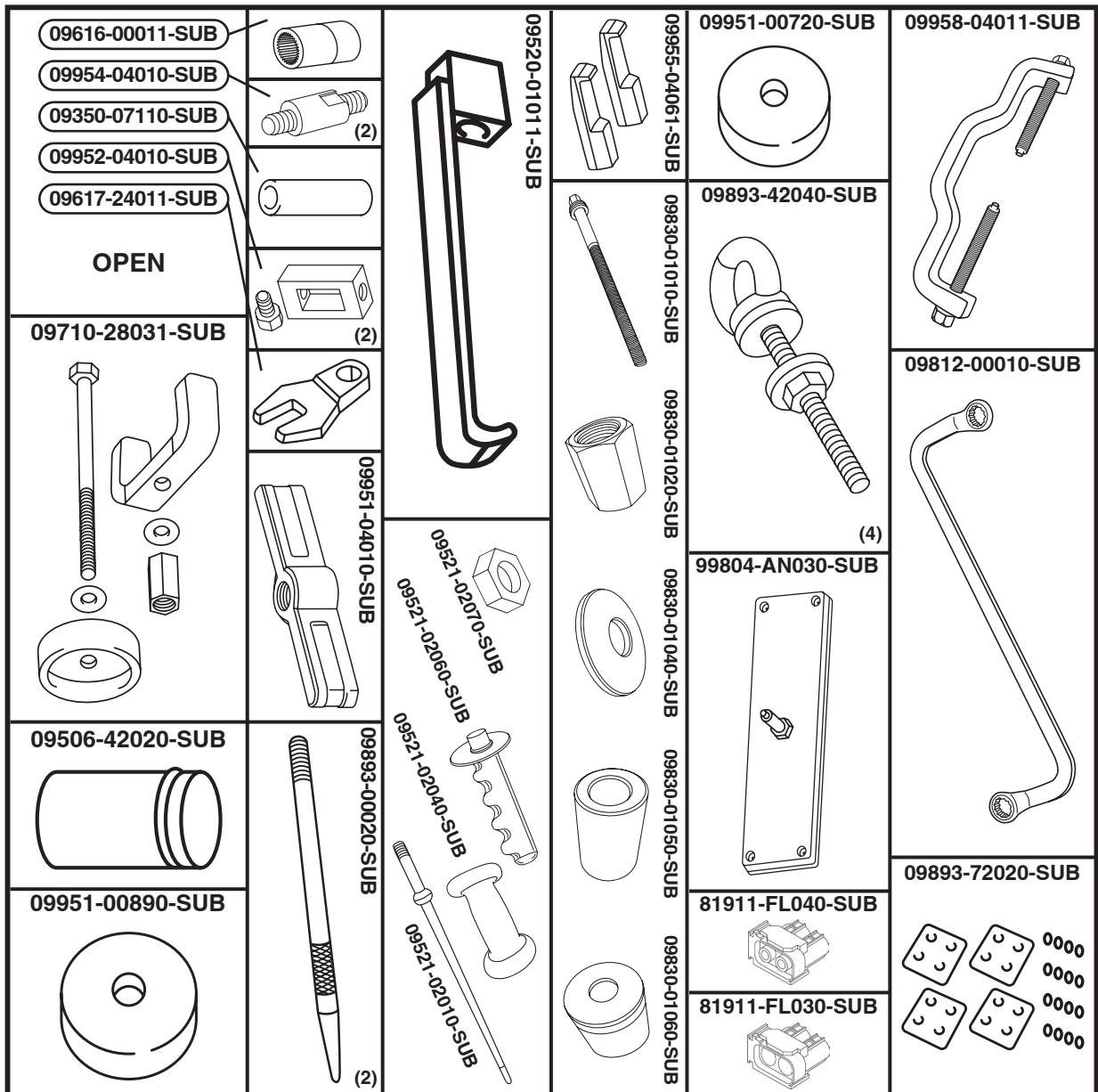





NOTE: GRAY HIGHLIGHTED TOOLS ARE NO LONGER ESSENTIAL.

Drawer Reference

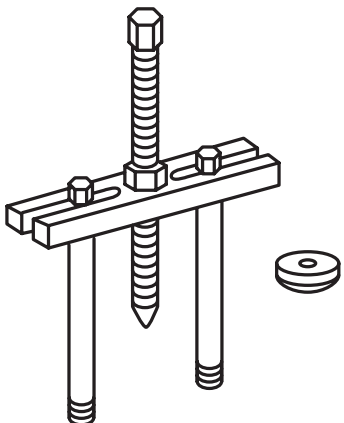
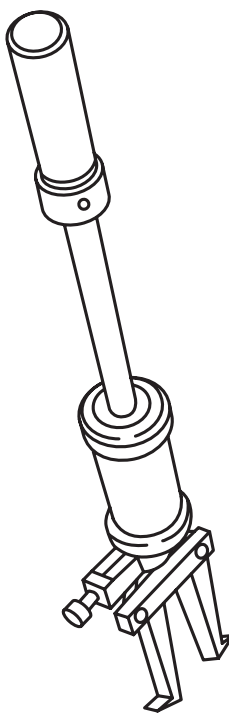
DRAWER 25

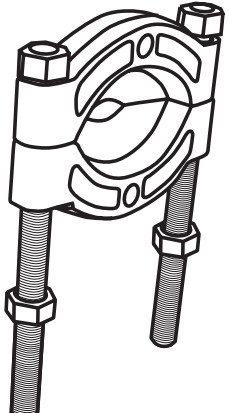
- 09308-00010-SUB OIL SEAL PULLER
- 09710-28031-SUB REPLACER SET
- 09729-00170-SUB EXTENSION WRENCH 17
- 09756-48050-SUB SUB HARNESS NO. 2
- 09950-00020-SUB BEARING REMOVER
- 09950-00030-SUB BEARING REMOVER ATTACHMENT
- 09951-00330-SUB REPLACER 33
- 09989-00020-SUB DIGITAL ATTACHMENT

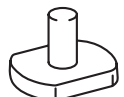
<p style="text-align: center;">OPEN</p>	<p style="text-align: center;">OPEN</p>	<p style="text-align: center;">OPEN</p>	<p style="text-align: center;">OPEN</p>	<p style="text-align: center;">09950-00030-SUB</p> 
<p style="text-align: center;">093080-00010-SUB</p> 		<p style="text-align: center;">09729-00170-SUB</p> 	<p style="text-align: center;">09756-48050-SUB</p> 	<p style="text-align: center;">09950-00020-SUB</p> 
			<p style="text-align: center;">09951-00330-SUB</p> 	
			<p style="text-align: center;">09989-00020-SUB</p> 	

NOTE: GRAY HIGHLIGHTED TOOLS ARE NO LONGER ESSENTIAL.

Drawer Reference

DRAWER 26

09870-60040-SUB REFLECTOR C

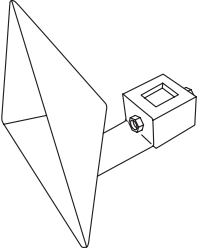
<p>OPEN</p>	
<p>OPEN</p>	
<p>09870-60040-SUB</p> 	

NOTE: GRAY HIGHLIGHTED TOOLS ARE NO LONGER ESSENTIAL.

Drawer Reference





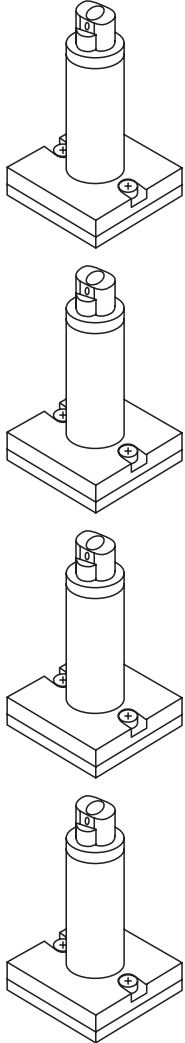
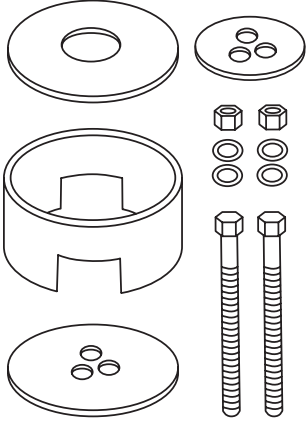
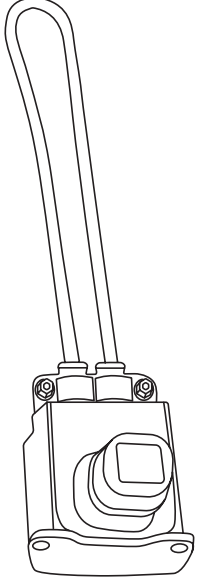
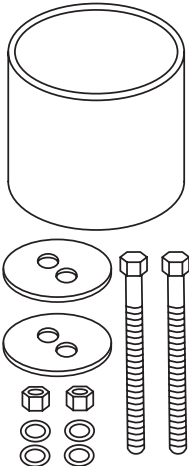
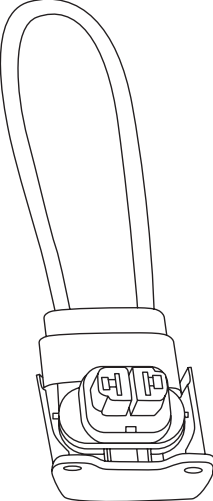





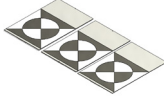
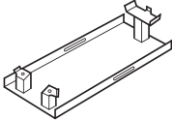
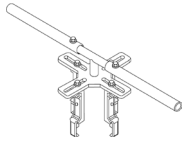
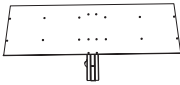
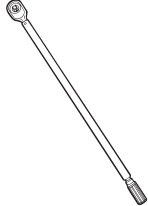

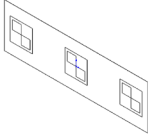
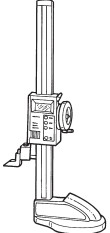

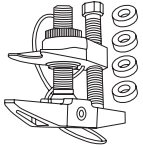
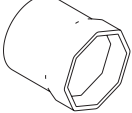
DRAWER 32

- 09570-24011-SUB REMOVE AND REPLACER (DIFFERENTIAL MOUNT CUSHION)
- 09570-48010-SUB REMOVE AND REPLACER (DIFFERENTIAL MOUNT CUSHION)
- 09893-72010-SUB LIFT ATTACHMENT SET
- 81911-FL010-SUB CONNECTOR HOLDER
- 81911-FL050-SUB CONNECTOR HOLDER

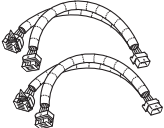
<p>09893-07010-SUB</p> 	<p>OPEN</p>	<p>OPEN</p>	<p style="text-align: center;">OPEN</p> <p style="text-align: center;">09570-24011-SUB</p> 	<p style="text-align: center;">81911-FL050-SUB</p> 
			<p style="text-align: center;">09570-48010-SUB</p> 	<p style="text-align: center;">81911-FL010-SUB</p> 

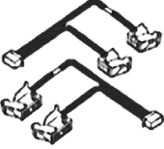
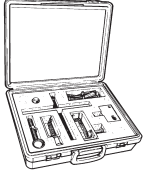

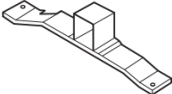
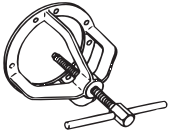
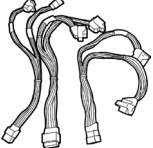
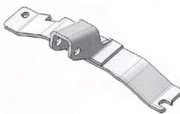

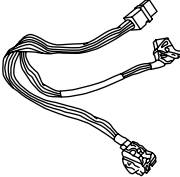
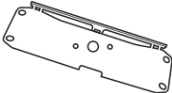
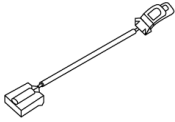

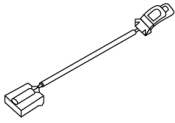

NOTE: GRAY HIGHLIGHTED TOOLS ARE NO LONGER ESSENTIAL.

OVERHEAD TOOLS

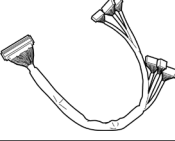
09870-52010-SUB TELEVISION CAMERA ADJUSTMENT TARGET 	18632AA010 STAND ASSEMBLY 	42099CC000 SPECIAL TOOL, FUEL PUMP 
09870-61100-SUB TARGET BOARD NO. 1 	18852AA000 TORQUE WRENCH 	697-95-0073 EVAP SYSTEM PRESSURE TESTER 
09870-62200-SUB TARGET BOARD NO. 2 	18853AA000 HEIGHT GAUGE 	697-96-0103 EVAP ADAPTER PLUG added to Kit 697-95-0073 
09960-20010-SUB BALL JOINT SET 	20099AE030 SUSPENSION DAMPER REMOVER 	697-96-0104 EVAP PASS THROUGH PLUG added to Kit 697-95-0073 
1587 FC FLUKE MEGA OHM METER 	22771AA030 SUBARU SELECT MONITOR II (SSMII/ NSM) 	86399XC000 PERIMETER CAMERA CALIBRATION CHART 
18460AA050 CHECKBOARD HARNESS 	28099PA010 FRONT HUB SUPPORT 	87599VA000 iCHART 
18460AA120 CHECKBOARD HARNESS 	28099PA040 HUB REMOVER 	87599YC001 iCHART ADA CAMERA 
18460AA150 CHECKBOARD HARNESS 	41099AA011 TRANSMISSION POWERTRAIN SUPPORT 	926470000 AXLE SHAFT PULLER 
18460AA180 CHECKBOARD HARNESS 	41099AA012 ENGINE SUPPORT BRACKET 	98299AN000 TEST HARNESS, AB MODULE DIAGNOSTICS 
18460AA190 CHECKBOARD HARNESS 	41099YCC001 TRANSMISSION SUPPORT 	98299CC000 TEST HARNESS BH 

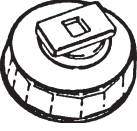
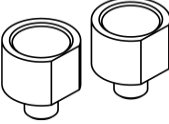
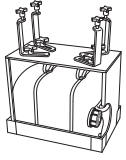
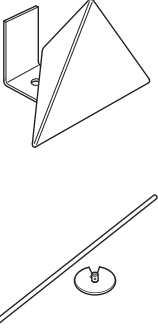
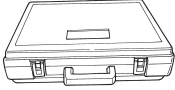
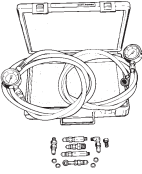
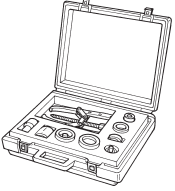
NOTE: GRAY HIGHLIGHTED TOOLS ARE NO LONGER ESSENTIAL.

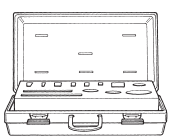

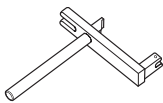

OVERHEAD TOOLS

98299CC010 TEST HARNESS BI		J-51311 HEV KIT	
98299XC000 HARNESS, BD TEST		J-51443 or VT36-0002 TPMS TESTER	
J-34274 OIL FILTER WRENCH		J-51658 ENGINE BRIDGE ADAPTER	
J-39401-B SIR DEPLOYMENT FIXTURE		SOA321103 BLIND SPOT RADAR REFLECTOR Includes: J-51661 Reflector J-51662 Base	
J-44159 VALVE SHIM STORAGE CASE		SOA639715-A PRESSURE GAUGE & ADAPTER SET	
J-44369 REAR SUSPENSION BUSHING KIT		J-45697 HUB REMOVER REPLACER KIT	
J-45697 HUB REMOVER REPLACER KIT		J-47606 SUBARU GLOBAL TERMINAL WIRING KIT	
J-50135-B ENGINE SUPPORT KIT (Includes all tools and adapters starting with J-50135, J-50135-A, and what was added through 2021.)	<p style="text-align: center;">Go to page 34 to see all tools.</p>	J-50972 TRUNK TORSION BAR	

NOTE: GRAY HIGHLIGHTED TOOLS ARE NO LONGER ESSENTIAL.

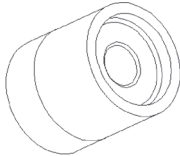
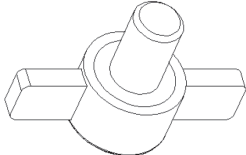
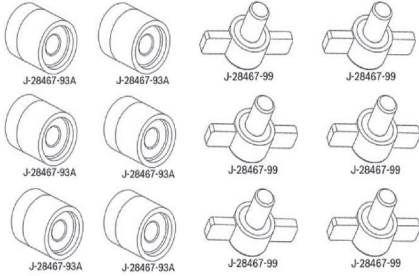
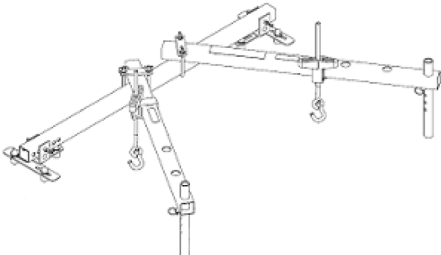
OVERHEAD TOOLS: J-50135-B ENGINE SUPPORT KIT

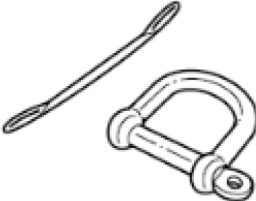
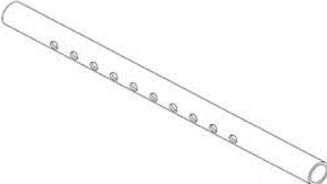

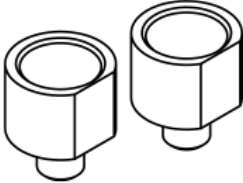
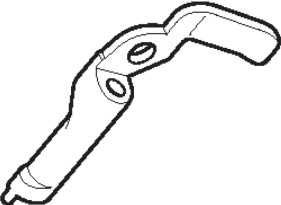
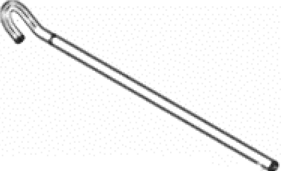

Engine Bridge accessories and configurations from 2009 Basic unit J-50135 + individual items OR replaced by full unit J-50135-B

	<p>J-28467-93A SUPPORT NUT 6 each included in J-28467-125A, which is included in J-50135-B Vehicles with 10 mm Strut Mount Studs</p>
	<p>J-28467-99 HOLD DOWN BOLT 6 each included in J-28467-125A, which is included in J-50135-B Vehicles with 10 mm Strut Mount Studs</p>
	<p>J-28467-125A ENGINE SUPPORT FIXTURE ADAPTERS Included in J-50135-B Vehicles with 10 mm Strut Mount Studs</p>
	<p>J-50135-B ENGINE SUPPORT BRIDGE Includes 2 Stanchions (legs) (J-50135-3) Each 13" long New Impreza 2009</p>
	<p>J-50136 ENGINE HANGER BRACKET H4 ENGINE Included with J-50135-B Engine Support Bridge New Impreza 2009</p>
	<p>J-50137 SLING AND SHACKLE Included with J-50135-B Engine Support Bridge Suspends engine New Impreza 2009</p>
	<p>J-50135-6 2 NEW ENGINE STANCHIONS (LEGS) Each 19" long BRZ (Used in place of J-50135-3 when working on BRZ)</p>
	<p>90119 14120 ENGINE BRACKET BOLT Used with 12281-38150 BRZ</p>

OVERHEAD TOOLS: J-50135-B ENGINE SUPPORT KIT

	<p>12281-38150 ENGINE BRACKET BRZ</p>
	<p>J-51658 2 ADAPTERS AT RADIATOR SUPPORT AREA Legacy/Outback 2015</p>
	<p>18360AA040 ENGINE HANGER Legacy/Outback 2015</p>
	<p>303-F070-6 ENGINE HOOK BRZ</p>

SHOP TOOLS

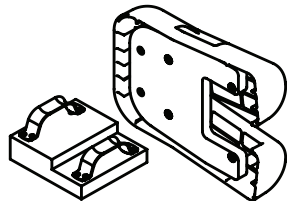
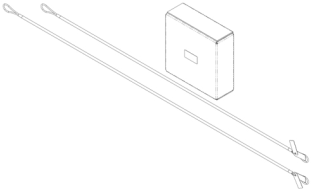
<p>2002 HYBRID BATTERY LIFTING CRANE (Hybrid Retailers Only)</p>	
<p>165-GR8-1100-SUB GR8 DIAGNOSTIC BATTERY CHARGER Replaced by 165-DCA-8000-SUB April 2019</p>	
<p>165-DCA-8000 SUB SUBARU DIAGNOSTIC BATTERY CHARGER Issued April 2019</p>	
<p>165-EXP-1000S-CW MIDTRONICS HAND HELD BATTERY TESTER Replaced by 165-DSS-5000-SUB December 2017</p>	
<p>165-DSS-5000-SUB MIDTRONICS HAND HELD BATTERY TESTER Issued December 2017</p>	
<p>J-47673 WEIGHT TOOL. PASSENGER</p>	
<p>J-52715 HYBRID BATTERY SLINGS (Hybrid Retailers Only)</p>	

NOTE: GRAY HIGHLIGHTED TOOLS ARE NO LONGER ESSENTIAL.

